

# 7 Real Numbers and the Pythagorean Theorem

7.1 Finding Square Roots

7.2 Finding Cube Roots

7.3 The Pythagorean Theorem

7.4 Approximating Square Roots

7.5 Using the Pythagorean Theorem

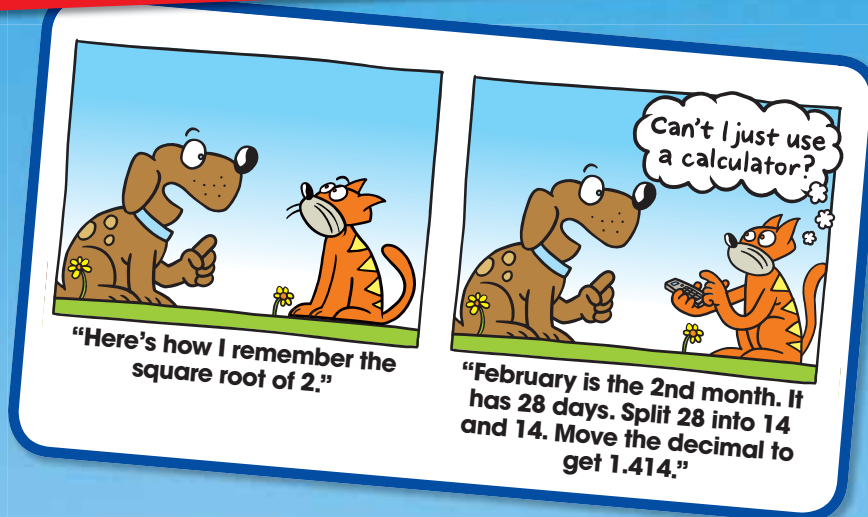
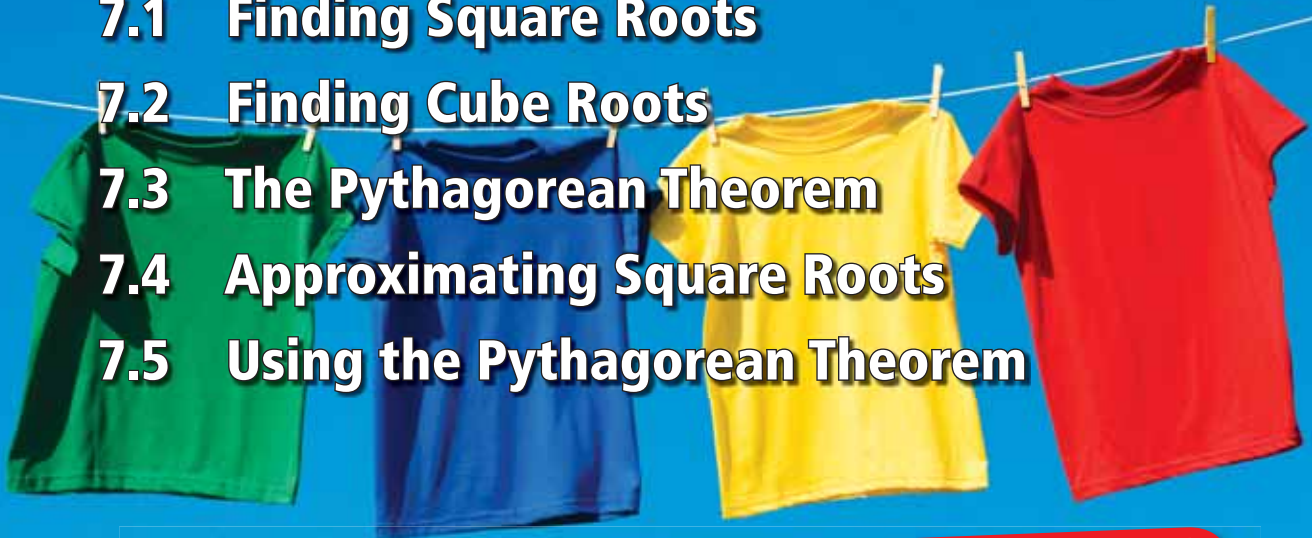

# What You Learned Before

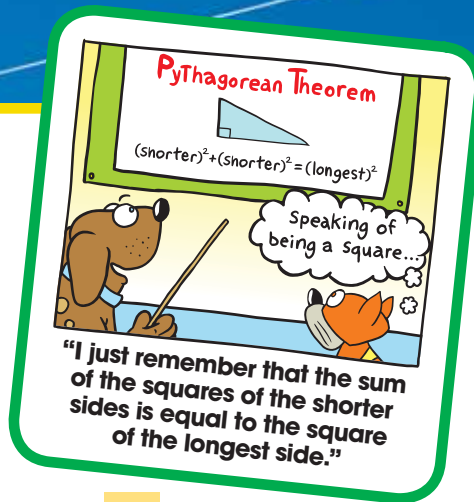

## Comparing Decimals (5.NBT.3b)

Complete the number sentence with  $<$ ,  $>$ , or  $=$ .

**Example 1** 1.1  1.01

Because  $\frac{110}{100}$  is greater than  $\frac{101}{100}$ ,  
1.1 is greater than 1.01.

So,  $1.1 > 1.01$ .

**Example 2**  $-0.3$    $-0.003$

Because  $-\frac{300}{1000}$  is less than  $-\frac{3}{1000}$ ,  
 $-0.3$  is less than  $-0.003$ .

So,  $-0.3 < -0.003$ .

**Example 3** Find three decimals that make the number sentence  $-5.12 >$   true.

Any decimal less than  $-5.12$  will make the sentence true.

Sample answer:  $-10.1$ ,  $-9.05$ ,  $-8.25$

### Try It Yourself

Complete the number sentence with  $<$ ,  $>$ , or  $=$ .

1.  $2.10$    $2.1$

2.  $-4.5$    $-4.25$

3.  $\pi$    $3.2$

Find three decimals that make the number sentence true.

4.  $-0.01 \leq$

5.  $1.75 >$

6.  $0.75 \geq$

## Using Order of Operations (7.NS.1, 7.NS.2)

**Example 4** Evaluate  $8^2 \div (32 \div 2) - 2(3 - 5)$ .

**First:** Parentheses

$$8^2 \div (32 \div 2) - 2(3 - 5) = 8^2 \div 16 - 2(-2)$$

**Second:** Exponents

$$= 64 \div 16 - 2(-2)$$

**Third:** Multiplication and Division (from left to right)

$$= 4 + 4$$

**Fourth:** Addition and Subtraction (from left to right)

$$= 8$$

### Try It Yourself

Evaluate the expression.

7.  $15\left(\frac{12}{3}\right) - 7^2 - 2 \cdot 7$

8.  $3^2 \cdot 4 \div 18 + 30 \cdot 6 - 1$

9.  $-1 + \left(\frac{4}{2}(6 - 1)\right)^2$

# 7.1 Finding Square Roots

**Essential Question** How can you find the dimensions of a square or a circle when you are given its area?

When you multiply a number by itself, you square the number.

Symbol for squaring is the exponent 2.

$$4^2 = 4 \cdot 4 = 16$$

4 squared is 16.

To “undo” this, take the *square root* of the number.

Symbol for square root is a radical sign,  $\sqrt{\quad}$ .

$$\sqrt{16} = \sqrt{4^2} = 4$$

The square root of 16 is 4.

## 1 ACTIVITY: Finding Square Roots

Work with a partner. Use a square root symbol to write the side length of the square. Then find the square root. Check your answer by multiplying.

a. Sample:  $s = \sqrt{121} = 11$  ft

Area =  $121 \text{ ft}^2$

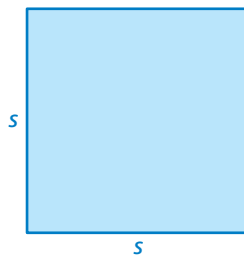

∴ The side length of the square is 11 feet.

**Check**

$$\begin{array}{r} 11 \\ \times 11 \\ \hline 11 \\ 110 \\ \hline 121 \end{array} \quad \checkmark$$

b. Area =  $81 \text{ yd}^2$

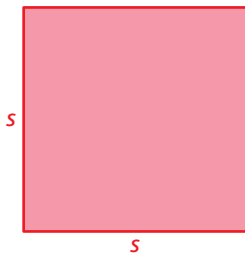

c. Area =  $324 \text{ cm}^2$

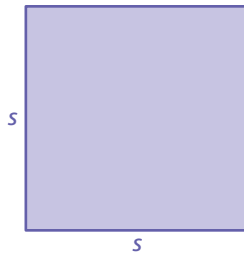

d. Area =  $361 \text{ mi}^2$

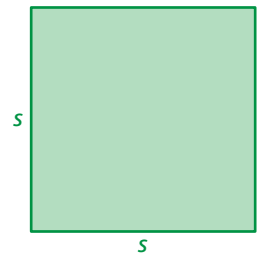

e. Area =  $225 \text{ mi}^2$



f. Area =  $2.89 \text{ in.}^2$

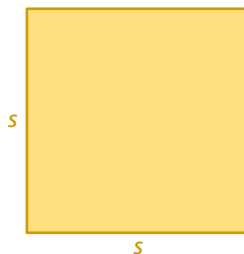

g. Area =  $\frac{4}{9} \text{ ft}^2$

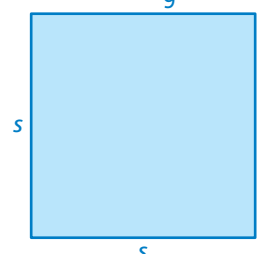

COMMON CORE

### Square Roots

In this lesson, you will

- find square roots of perfect squares.
- evaluate expressions involving square roots.
- use square roots to solve equations.

Learning Standard 8.EE.2

## 2 ACTIVITY: Using Square Roots

Work with a partner. Find the radius of each circle.

a.

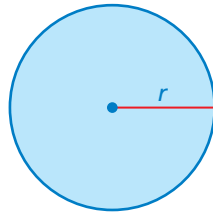

$$\text{Area} = 36\pi \text{ in.}^2$$

b.

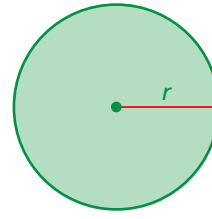

$$\text{Area} = \pi \text{ yd}^2$$

c.

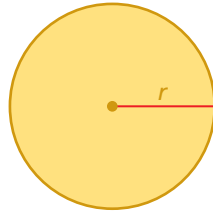

$$\text{Area} = 0.25\pi \text{ ft}^2$$

d.

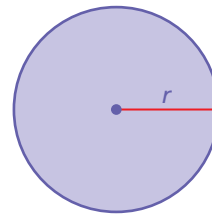

$$\text{Area} = \frac{9}{16}\pi \text{ m}^2$$

## 3 ACTIVITY: The Period of a Pendulum

### Math Practice 6

#### Calculate Accurately

How can you use the graph to help you determine whether you calculated the values of  $T$  correctly?

Work with a partner.

The **period of a pendulum** is the time (in seconds) it takes the pendulum to swing back *and* forth.

The period  $T$  is represented by  $T = 1.1\sqrt{L}$ , where  $L$  is the length of the pendulum (in feet).

Copy and complete the table. Then graph the function. Is the function linear?

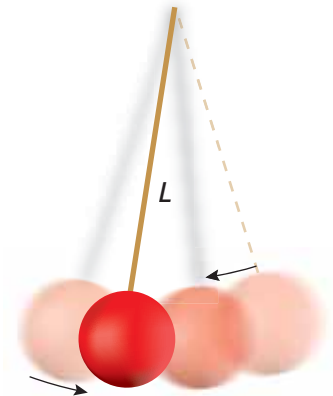

$L$	1.00	1.96	3.24	4.00	4.84	6.25	7.29	7.84	9.00
$T$									

## What Is Your Answer?

4. **IN YOUR OWN WORDS** How can you find the dimensions of a square or a circle when you are given its area? Give an example of each. How can you check your answers?

### Practice

Use what you learned about finding square roots to complete Exercises 4–6 on page 292.



# 7.1 Lesson

## Key Vocabulary

square root, p. 290  
perfect square, p. 290  
radical sign, p. 290  
radicand, p. 290

A **square root** of a number is a number that, when multiplied by itself, equals the given number. Every positive number has a positive *and* a negative square root. A **perfect square** is a number with integers as its square roots.

## EXAMPLE 1 Finding Square Roots of a Perfect Square

Find the two square roots of 49.

$$7 \cdot 7 = 49 \text{ and } (-7) \cdot (-7) = 49$$

∴ So, the square roots of 49 are 7 and  $-7$ .

The symbol  $\sqrt{\quad}$  is called a **radical sign**. It is used to represent a square root. The number under the radical sign is called the **radicand**.

## Study Tip

Zero has one square root, which is 0.

Positive Square Root, $\sqrt{\quad}$	Negative Square Root, $-\sqrt{\quad}$	Both Square Roots, $\pm\sqrt{\quad}$
$\sqrt{16} = 4$	$-\sqrt{16} = -4$	$\pm\sqrt{16} = \pm 4$

## EXAMPLE 2 Finding Square Roots

Find the square root(s).

a.  $\sqrt{25}$

∴ Because  $5^2 = 25$ ,  $\sqrt{25} = \sqrt{5^2} = 5$ .

$\sqrt{25}$  represents the positive square root.

b.  $-\sqrt{\frac{9}{16}}$

∴ Because  $\left(\frac{3}{4}\right)^2 = \frac{9}{16}$ ,  $-\sqrt{\frac{9}{16}} = -\sqrt{\left(\frac{3}{4}\right)^2} = -\frac{3}{4}$ .

$-\sqrt{\frac{9}{16}}$  represents the negative square root.

c.  $\pm\sqrt{2.25}$

∴ Because  $1.5^2 = 2.25$ ,  $\pm\sqrt{2.25} = \pm\sqrt{1.5^2} = 1.5$  and  $-1.5$ .

$\pm\sqrt{2.25}$  represents both the positive and the negative square roots.

## On Your Own

Find the two square roots of the number.

1. 36

2. 100

3. 121

Find the square root(s).

4.  $-\sqrt{1}$

5.  $\pm\sqrt{\frac{4}{25}}$

6.  $\sqrt{12.25}$

Now You're Ready  
Exercises 7–18

Squaring a positive number and finding a square root are inverse operations. You can use this relationship to evaluate expressions and solve equations involving squares.

### EXAMPLE 3 Evaluating Expressions Involving Square Roots

Evaluate each expression.

a.  $5\sqrt{36} + 7 = 5(6) + 7$  Evaluate the square root.  
 $= 30 + 7$  Multiply.  
 $= 37$  Add.

b.  $\frac{1}{4} + \sqrt{\frac{18}{2}} = \frac{1}{4} + \sqrt{9}$  Simplify.  
 $= \frac{1}{4} + 3$  Evaluate the square root.  
 $= 3\frac{1}{4}$  Add.

c.  $(\sqrt{81})^2 - 5 = 81 - 5$  Evaluate the power using inverse operations.  
 $= 76$  Subtract.

### EXAMPLE 4 Real-Life Application



The area of a crop circle is 45,216 square feet. What is the radius of the crop circle? Use 3.14 for  $\pi$ .

$A = \pi r^2$  Write the formula for the area of a circle.

$45,216 \approx 3.14r^2$  Substitute 45,216 for  $A$  and 3.14 for  $\pi$ .

$14,400 = r^2$  Divide each side by 3.14.

$\sqrt{14,400} = \sqrt{r^2}$  Take positive square root of each side.

$120 = r$  Simplify.

∴ The radius of the crop circle is about 120 feet.

#### On Your Own

Evaluate the expression.

7.  $12 - 3\sqrt{25}$

8.  $\sqrt{\frac{28}{7}} + 2.4$

9.  $15 - (\sqrt{4})^2$

10. The area of a circle is 2826 square feet. Write and solve an equation to find the radius of the circle. Use 3.14 for  $\pi$ .

Now You're Ready  
Exercises 20–27

## Vocabulary and Concept Check

- VOCABULARY** Is 26 a perfect square? Explain.
- REASONING** Can the square of an integer be a negative number? Explain.
- NUMBER SENSE** Does  $\sqrt{256}$  represent the positive square root of 256, the negative square root of 256, or both? Explain.

## Practice and Problem Solving

Find the dimensions of the square or circle. Check your answer.

4. Area =  $441 \text{ cm}^2$

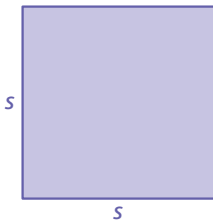

5. Area =  $1.69 \text{ km}^2$

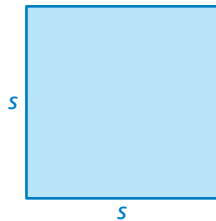

6. Area =  $64\pi \text{ in.}^2$

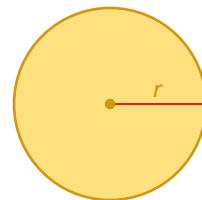

Find the two square roots of the number.

1. 9                      8. 64                      9. 4                      10. 144

Find the square root(s).

2. 11.  $\sqrt{625}$                       12.  $\pm\sqrt{196}$                       13.  $\pm\sqrt{\frac{1}{961}}$                       14.  $-\sqrt{\frac{9}{100}}$   
 15.  $\pm\sqrt{4.84}$                       16.  $\sqrt{7.29}$                       17.  $-\sqrt{361}$                       18.  $-\sqrt{2.25}$

19. **ERROR ANALYSIS** Describe and correct the error in finding the square roots.

**X**  $\pm\sqrt{\frac{1}{4}} = \frac{1}{2}$

Evaluate the expression.

3. 20.  $(\sqrt{9})^2 + 5$                       21.  $28 - (\sqrt{144})^2$                       22.  $3\sqrt{16} - 5$                       23.  $10 - 4\sqrt{\frac{1}{16}}$   
 24.  $\sqrt{6.76} + 5.4$                       25.  $8\sqrt{8.41} + 1.8$                       26.  $2\left(\sqrt{\frac{80}{5}} - 5\right)$                       27.  $4\left(\sqrt{\frac{147}{3}} + 3\right)$

28. **NOTEPAD** The area of the base of a square notepad is 2.25 square inches. What is the length of one side of the base of the notepad?
29. **CRITICAL THINKING** There are two square roots of 25. Why is there only one answer for the radius of the button?



$A = 25\pi \text{ mm}^2$

Copy and complete the statement with  $<$ ,  $>$ , or  $=$ .

30.  $\sqrt{81}$    8

31.  $0.5$     $\sqrt{0.25}$

32.  $\frac{3}{2}$     $\sqrt{\frac{25}{4}}$

33. **SAILBOAT** The area of a sail is  $40\frac{1}{2}$  square feet. The base and the height of the sail are equal. What is the height of the sail (in feet)?

34. **REASONING** Is the product of two perfect squares always a perfect square? Explain your reasoning.

35. **ENERGY** The kinetic energy  $K$  (in joules) of a falling apple is represented by  $K = \frac{v^2}{2}$ , where  $v$  is the speed of the apple (in meters per second). How fast is the apple traveling when the kinetic energy is 32 joules?

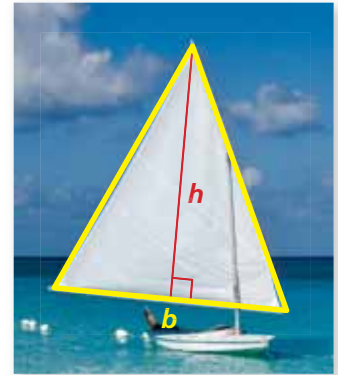

36. **PRECISION** The areas of the two watch faces have a ratio of 16 : 25.

- a. What is the ratio of the radius of the smaller watch face to the radius of the larger watch face?
- b. What is the radius of the larger watch face?

37. **WINDOW** The cost  $C$  (in dollars) of making a square window with a side length of  $n$  inches is represented by  $C = \frac{n^2}{5} + 175$ . A window costs \$355. What is the length (in feet) of the window?

38. **Geometry** The area of the triangle is represented by the formula  $A = \sqrt{s(s - 21)(s - 17)(s - 10)}$ , where  $s$  is equal to half the perimeter. What is the height of the triangle?

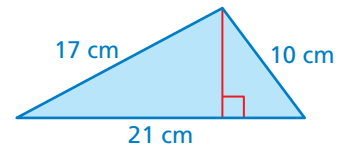

## Fair Game Review What you learned in previous grades & lessons

Write in slope-intercept form an equation of the line that passes through the given points. (Section 4.7)

39. (2, 4), (5, 13)

40. (-1, 7), (3, -1)

41. (-5, -2), (5, 4)

42. **MULTIPLE CHOICE** What is the value of  $x$ ? (Section 3.2)

(A) 41

(B) 44

(C) 88

(D) 134

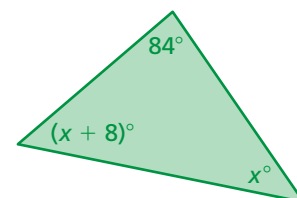

## 7.2 Finding Cube Roots

**Essential Question** How is the cube root of a number different from the square root of a number?

When you multiply a number by itself twice, you cube the number.

Symbol for cubing is the exponent 3.

$$4^3 = 4 \cdot 4 \cdot 4 = 64 \quad \text{4 cubed is 64.}$$

To “undo” this, take the *cube root* of the number.

Symbol for cube root is  $\sqrt[3]{\quad}$ .

$$\sqrt[3]{64} = \sqrt[3]{4^3} = 4 \quad \text{The cube root of 64 is 4.}$$

### 1 ACTIVITY: Finding Cube Roots

Work with a partner. Use a cube root symbol to write the edge length of the cube. Then find the cube root. Check your answer by multiplying.

a. **Sample:**

$$s = \sqrt[3]{343} = \sqrt[3]{7^3} = 7 \text{ inches}$$

$$\text{Volume} = 343 \text{ in.}^3$$

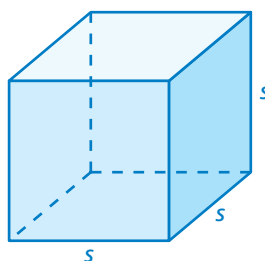

**Check**

$$7 \cdot 7 \cdot 7 = 49 \cdot 7 = 343 \quad \checkmark$$

∴ The edge length of the cube is 7 inches.

b. **Volume = 27 ft<sup>3</sup>**

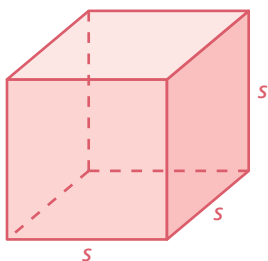

c. **Volume = 125 m<sup>3</sup>**

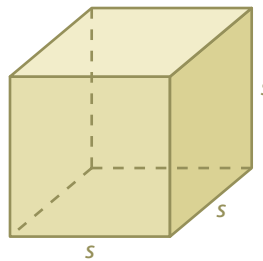

d. **Volume = 0.001 cm<sup>3</sup>**

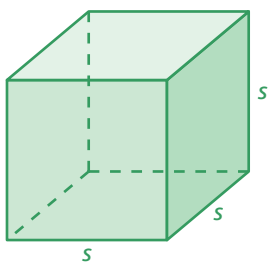

e. **Volume =  $\frac{1}{8}$  yd<sup>3</sup>**

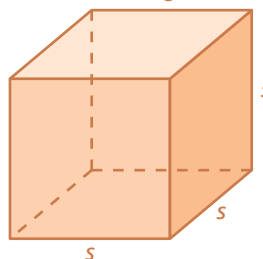

**COMMON CORE**

#### Cube Roots

In this lesson, you will

- find cube roots of perfect cubes.
- evaluate expressions involving cube roots.
- use cube roots to solve equations.

Learning Standard 8.EE.2



## 2 ACTIVITY: Using Prime Factorizations to Find Cube Roots

### Math Practice 7

#### View as Components

When writing the prime factorizations in Activity 2, how many times do you expect to see each factor? Why?

Work with a partner. Write the prime factorization of each number. Then use the prime factorization to find the cube root of the number.

a. 216

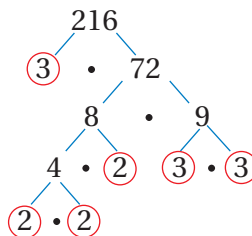

$$216 = 3 \cdot 2 \cdot 3 \cdot 3 \cdot 2 \cdot 2$$

$$= (3 \cdot \square) \cdot (3 \cdot \square) \cdot (3 \cdot \square)$$

$$= \square \cdot \square \cdot \square$$

Prime factorization

Commutative Property of Multiplication

Simplify.

∴ The cube root of 216 is  $\square$ .

b. 1000

c. 3375

d. **STRUCTURE** Does this procedure work for every number? Explain why or why not.

### What Is Your Answer?

- Complete each statement using *positive* or *negative*.
  - A positive number times a positive number is a \_\_\_\_\_ number.
  - A negative number times a negative number is a \_\_\_\_\_ number.
  - A positive number multiplied by itself twice is a \_\_\_\_\_ number.
  - A negative number multiplied by itself twice is a \_\_\_\_\_ number.
- REASONING** Can a negative number have a cube root? Give an example to support your explanation.
- IN YOUR OWN WORDS** How is the cube root of a number different from the square root of a number?
- Give an example of a number whose square root and cube root are equal.
- A cube has a volume of 13,824 cubic meters. Use a calculator to find the edge length.

### Practice

Use what you learned about cube roots to complete Exercises 3–5 on page 298.

**Key Vocabulary**

cube root, p. 296  
perfect cube, p. 296

A **cube root** of a number is a number that, when multiplied by itself, and then multiplied by itself again, equals the given number. A **perfect cube** is a number that can be written as the cube of an integer. The symbol  $\sqrt[3]{\phantom{x}}$  is used to represent a cube root.

**EXAMPLE 1 Finding Cube Roots**

Find each cube root.

a.  $\sqrt[3]{8}$

Because  $2^3 = 8$ ,  $\sqrt[3]{8} = \sqrt[3]{2^3} = 2$ .

b.  $\sqrt[3]{-27}$

Because  $(-3)^3 = -27$ ,  $\sqrt[3]{-27} = \sqrt[3]{(-3)^3} = -3$ .

c.  $\sqrt[3]{\frac{1}{64}}$

Because  $\left(\frac{1}{4}\right)^3 = \frac{1}{64}$ ,  $\sqrt[3]{\frac{1}{64}} = \sqrt[3]{\left(\frac{1}{4}\right)^3} = \frac{1}{4}$ .

Cubing a number and finding a cube root are inverse operations. You can use this relationship to evaluate expressions and solve equations involving cubes.

**EXAMPLE 2 Evaluating Expressions Involving Cube Roots**

Evaluate each expression.

a.  $2\sqrt[3]{-216} - 3 = 2(-6) - 3$

Evaluate the cube root.

$$= -12 - 3$$

Multiply.

$$= -15$$

Subtract.

b.  $(\sqrt[3]{125})^3 + 21 = 125 + 21$

Evaluate the power using inverse operations.

$$= 146$$

Add.

**On Your Own**

Find the cube root.

1.  $\sqrt[3]{1}$

2.  $\sqrt[3]{-343}$

3.  $\sqrt[3]{-\frac{27}{1000}}$

Evaluate the expression.

4.  $18 - 4\sqrt[3]{8}$

5.  $(\sqrt[3]{-64})^3 + 43$

6.  $5\sqrt[3]{512} - 19$

**Now You're Ready**  
Exercises 6–17

### EXAMPLE 3 Evaluating an Algebraic Expression

Evaluate  $\frac{x}{4} + \sqrt[3]{\frac{x}{3}}$  when  $x = 192$ .

$$\frac{x}{4} + \sqrt[3]{\frac{x}{3}} = \frac{192}{4} + \sqrt[3]{\frac{192}{3}} \quad \text{Substitute 192 for } x.$$

$$= 48 + \sqrt[3]{64} \quad \text{Simplify.}$$

$$= 48 + 4 \quad \text{Evaluate the cube root.}$$

$$= 52 \quad \text{Add.}$$

#### On Your Own

 **Now You're Ready**  
Exercises 18–20

Evaluate the expression for the given value of the variable.

7.  $\sqrt[3]{8y} + y, y = 64$

8.  $2b - \sqrt[3]{9b}, b = -3$

### EXAMPLE 4 Real-Life Application

Find the surface area of the baseball display case.

The baseball display case is in the shape of a cube. Use the formula for the volume of a cube to find the edge length  $s$ .

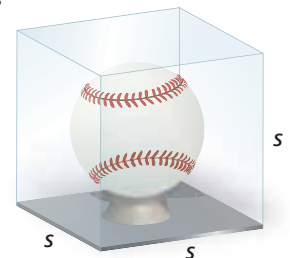

Volume =  $125 \text{ in.}^3$

#### Remember

The volume  $V$  of a cube with edge length  $s$  is given by  $V = s^3$ . The surface area  $S$  is given by  $S = 6s^2$ .

$$V = s^3 \quad \text{Write formula for volume.}$$

$$125 = s^3 \quad \text{Substitute 125 for } V.$$

$$\sqrt[3]{125} = \sqrt[3]{s^3} \quad \text{Take the cube root of each side.}$$

$$5 = s \quad \text{Simplify.}$$

The edge length is 5 inches. Use a formula to find the surface area of the cube.

$$S = 6s^2 \quad \text{Write formula for surface area.}$$

$$= 6(5)^2 \quad \text{Substitute 5 for } s.$$

$$= 150 \quad \text{Simplify.}$$

∴ So, the surface area of the baseball display case is 150 square inches.

#### On Your Own

9. The volume of a music box that is shaped like a cube is 512 cubic centimeters. Find the surface area of the music box.



**Vocabulary and Concept Check**

- VOCABULARY** Is 25 a perfect cube? Explain.
- REASONING** Can the cube of an integer be a negative number? Explain.

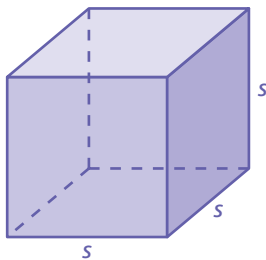

**Practice and Problem Solving**

Find the edge length of the cube.

3. Volume =  $125,000 \text{ in.}^3$

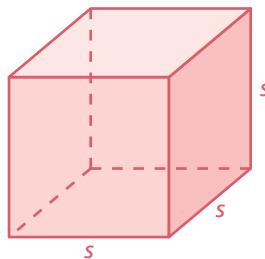

4. Volume =  $\frac{1}{27} \text{ ft}^3$



5. Volume =  $0.064 \text{ m}^3$

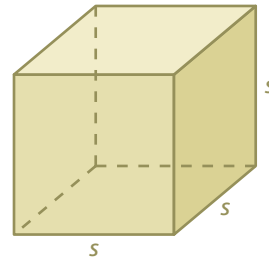

Find the cube root.

1 6.  $\sqrt[3]{729}$

7.  $\sqrt[3]{-125}$

8.  $\sqrt[3]{-1000}$

9.  $\sqrt[3]{1728}$

10.  $\sqrt[3]{-\frac{1}{512}}$

11.  $\sqrt[3]{\frac{343}{64}}$

Evaluate the expression.

2 12.  $18 - (\sqrt[3]{27})^3$

13.  $(\sqrt[3]{-\frac{1}{8}})^3 + 3\frac{3}{4}$

14.  $5\sqrt[3]{729} - 24$

15.  $\frac{1}{4} - 2\sqrt[3]{-\frac{1}{216}}$

16.  $54 + \sqrt[3]{-4096}$

17.  $4\sqrt[3]{8000} - 6$

Evaluate the expression for the given value of the variable.

3 18.  $\sqrt[3]{\frac{n}{4}} + \frac{n}{10}$ ,  $n = 500$

19.  $\sqrt[3]{6w} - w$ ,  $w = 288$

20.  $2d + \sqrt[3]{-45d}$ ,  $d = 75$

21. **STORAGE CUBE** The volume of a plastic storage cube is 27,000 cubic centimeters. What is the edge length of the storage cube?

22. **ICE SCULPTURE** The volume of a cube of ice for an ice sculpture is 64,000 cubic inches.
- What is the edge length of the cube of ice?
  - What is the surface area of the cube of ice?



Copy and complete the statement with  $<$ ,  $>$ , or  $=$ .

23.  $-\frac{1}{4}$     $\sqrt[3]{-\frac{8}{125}}$

24.  $\sqrt[3]{0.001}$     $0.01$

25.  $\sqrt[3]{64}$     $\sqrt{64}$

26. **DRAG RACE** The estimated velocity  $v$  (in miles per hour) of a car at the end of a drag race is  $v = 234\sqrt[3]{\frac{p}{w}}$ , where  $p$  is the horsepower of the car and  $w$  is the weight (in pounds) of the car. A car has a horsepower of 1311 and weighs 2744 pounds. Find the velocity of the car at the end of a drag race. Round your answer to the nearest whole number.



27. **NUMBER SENSE** There are three numbers that are their own cube roots. What are the numbers?
28. **LOGIC** Each statement below is true for square roots. Determine whether the statement is also true for cube roots. Explain your reasoning and give an example to support your explanation.
- You cannot find the square root of a negative number.
  - Every positive number has a positive square root and a negative square root.

29. **GEOMETRY** The pyramid has a volume of 972 cubic inches. What are the dimensions of the pyramid?

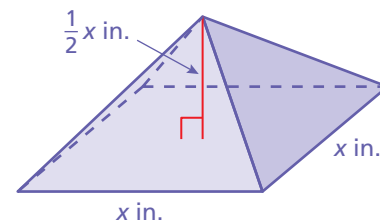

30. **RATIOS** The ratio  $125 : x$  is equivalent to the ratio  $x^2 : 125$ . What is the value of  $x$ ?

**Critical Thinking** Solve the equation.

31.  $(3x + 4)^3 = 2197$

32.  $(8x^3 - 9)^3 = 5832$

33.  $((5x - 16)^3 - 4)^3 = 216,000$



## Fair Game Review what you learned in previous grades & lessons

Evaluate the expression. *(Skills Review Handbook)*

34.  $3^2 + 4^2$

35.  $8^2 + 15^2$

36.  $13^2 - 5^2$

37.  $25^2 - 24^2$

38. **MULTIPLE CHOICE** Which linear function is shown by the table? *(Section 6.3)*

<b>x</b>	1	2	3	4
<b>y</b>	4	7	10	13

(A)  $y = \frac{1}{3}x + 1$

(B)  $y = 4x$

(C)  $y = 3x + 1$

(D)  $y = \frac{1}{4}x$



## 7.3 The Pythagorean Theorem

**Essential Question** How are the lengths of the sides of a right triangle related?

Pythagoras was a Greek mathematician and philosopher who discovered one of the most famous rules in mathematics. In mathematics, a rule is called a **theorem**. So, the rule that Pythagoras discovered is called the Pythagorean Theorem.



Pythagoras  
(c. 570–c. 490 B.C.)

### 1 ACTIVITY: Discovering the Pythagorean Theorem

Work with a partner.

- On grid paper, draw any right triangle. Label the lengths of the two shorter sides  $a$  and  $b$ .
  - Label the length of the longest side  $c$ .
  - Draw squares along each of the three sides. Label the areas of the three squares  $a^2$ ,  $b^2$ , and  $c^2$ .
  - Cut out the three squares. Make eight copies of the right triangle and cut them out. Arrange the figures to form two identical larger squares.
- e. MODELING** The Pythagorean Theorem describes the relationship among  $a^2$ ,  $b^2$ , and  $c^2$ . Use your result from part (d) to write an equation that describes this relationship.

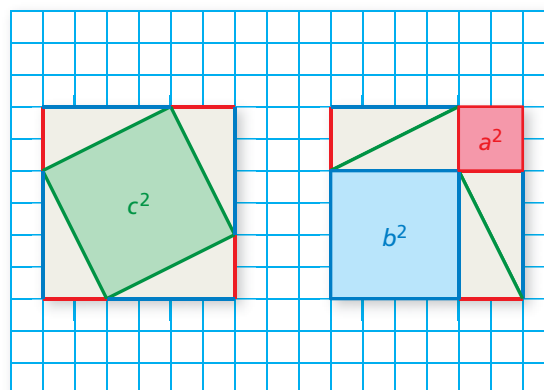
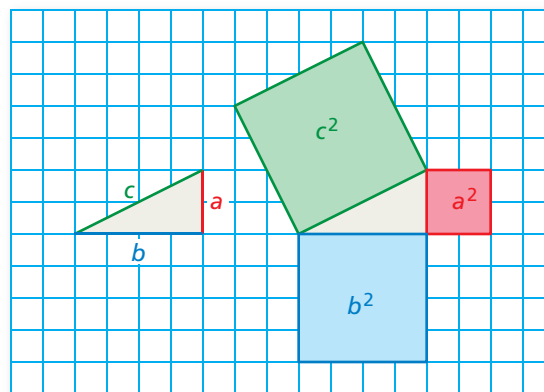

COMMON  
CORE

#### Pythagorean Theorem

In this lesson, you will

- provide geometric proof of the Pythagorean Theorem.
- use the Pythagorean Theorem to find missing side lengths of right triangles.
- solve real-life problems.

Learning Standards

- 8.EE.2
- 8.G.6
- 8.G.7
- 8.G.8

## 2 ACTIVITY: Using the Pythagorean Theorem in Two Dimensions

Work with a partner. Use a ruler to measure the longest side of each right triangle. Verify the result of Activity 1 for each right triangle.

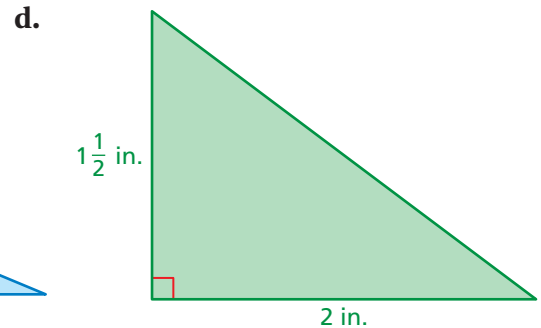
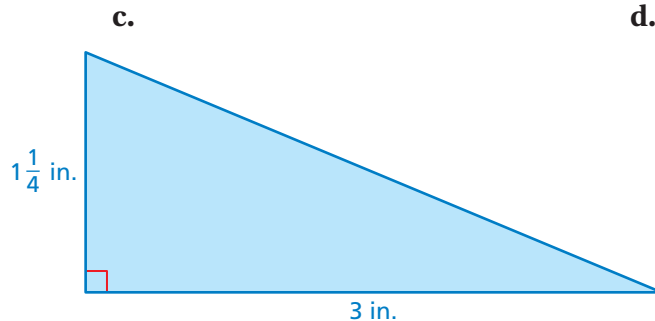
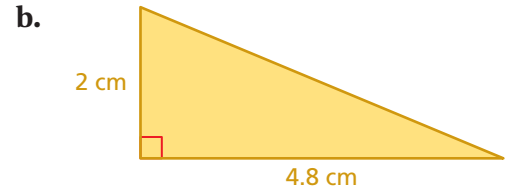
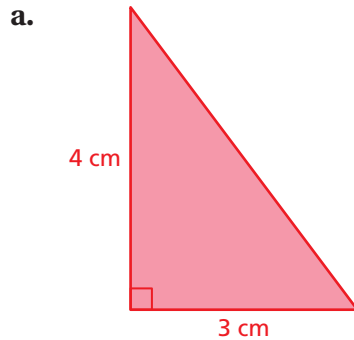

## 3 ACTIVITY: Using the Pythagorean Theorem in Three Dimensions

### Math Practice 3

#### Use Definitions

How can you use what you know about the Pythagorean Theorem to describe the procedure for finding the length of the guy wire?

Work with a partner. A guy wire attached 24 feet above ground level on a telephone pole provides support for the pole.

- PROBLEM SOLVING** Describe a procedure that you could use to find the length of the guy wire without directly measuring the wire.
- Find the length of the wire when it meets the ground 10 feet from the base of the pole.

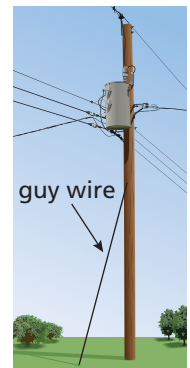

## What Is Your Answer?

- IN YOUR OWN WORDS** How are the lengths of the sides of a right triangle related? Give an example using whole numbers.

### Practice

Use what you learned about the Pythagorean Theorem to complete Exercises 3 and 4 on page 304.

## Key Vocabulary

theorem, p. 300  
legs, p. 302  
hypotenuse, p. 302  
Pythagorean  
Theorem, p. 302

## Study Tip

In a right triangle, the legs are the shorter sides and the hypotenuse is always the longest side.

## Key Ideas

### Sides of a Right Triangle

The sides of a right triangle have special names.

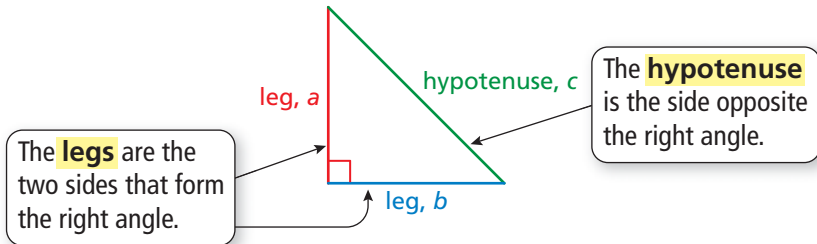

### The Pythagorean Theorem

**Words** In any right triangle, the sum of the squares of the lengths of the legs is equal to the square of the length of the hypotenuse.

**Algebra**  $a^2 + b^2 = c^2$

## EXAMPLE 1 Finding the Length of a Hypotenuse

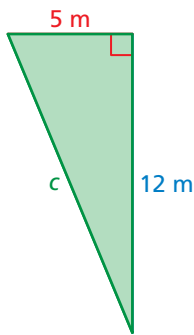

Find the length of the hypotenuse of the triangle.

$$a^2 + b^2 = c^2$$

Write the Pythagorean Theorem.

$$5^2 + 12^2 = c^2$$

Substitute 5 for  $a$  and 12 for  $b$ .

$$25 + 144 = c^2$$

Evaluate powers.

$$169 = c^2$$

Add.

$$\sqrt{169} = \sqrt{c^2}$$

Take positive square root of each side.

$$13 = c$$

Simplify.

∴ The length of the hypotenuse is 13 meters.

## On Your Own

Find the length of the hypotenuse of the triangle.

Now You're Ready  
Exercises 3 and 4

1.

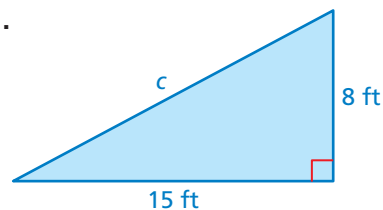

2.

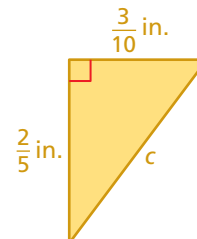

## EXAMPLE 2 Finding the Length of a Leg

Find the missing length of the triangle.

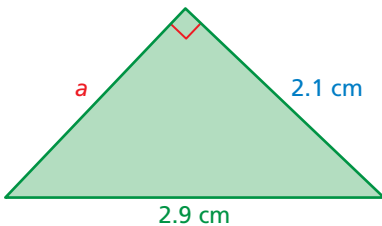

$$a^2 + b^2 = c^2$$

Write the Pythagorean Theorem.

$$a^2 + 2.1^2 = 2.9^2$$

Substitute 2.1 for  $b$  and 2.9 for  $c$ .

$$a^2 + 4.41 = 8.41$$

Evaluate powers.

$$a^2 = 4$$

Subtract 4.41 from each side.

$$a = 2$$

Take positive square root of each side.

∴ The missing length is 2 centimeters.

## EXAMPLE 3 Real-Life Application

You are playing capture the flag. You are 50 yards north and 20 yards east of your team's base. The other team's base is 80 yards north and 60 yards east of your base. How far are you from the other team's base?

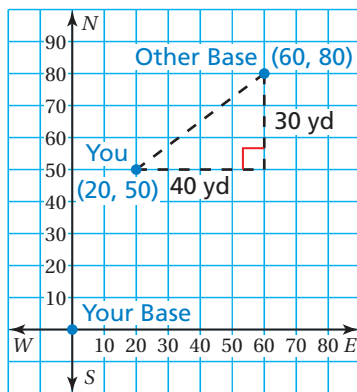

**Step 1:** Draw the situation in a coordinate plane. Let the origin represent your team's base. From the descriptions, you are at (20, 50) and the other team's base is at (60, 80).

**Step 2:** Draw a right triangle with a hypotenuse that represents the distance between you and the other team's base. The lengths of the legs are 30 yards and 40 yards.

**Step 3:** Use the Pythagorean Theorem to find the length of the hypotenuse.

$$a^2 + b^2 = c^2$$

Write the Pythagorean Theorem.

$$30^2 + 40^2 = c^2$$

Substitute 30 for  $a$  and 40 for  $b$ .

$$900 + 1600 = c^2$$

Evaluate powers.

$$2500 = c^2$$

Add.

$$50 = c$$

Take positive square root of each side.

∴ So, you are 50 yards from the other team's base.

### On Your Own

Find the missing length of the triangle.

3.



4.

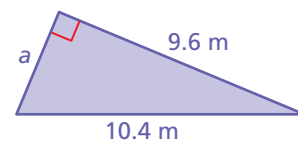

5. In Example 3, what is the distance between the bases?

Now You're Ready  
Exercises 5–8

## Vocabulary and Concept Check

- VOCABULARY** In a right triangle, how can you tell which sides are the legs and which side is the hypotenuse?
- DIFFERENT WORDS, SAME QUESTION** Which is different? Find “both” answers.

Which side is the hypotenuse?

Which side is the longest?

Which side is a leg?

Which side is opposite the right angle?

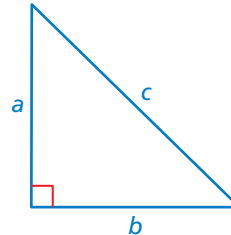

## Practice and Problem Solving

Find the missing length of the triangle.

1 2 3.

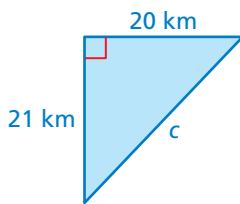

4.

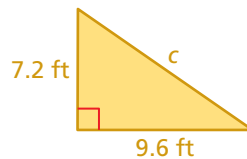

5.

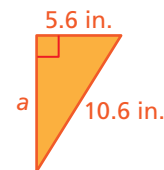

6.

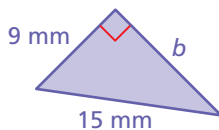

7.

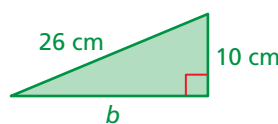

8.

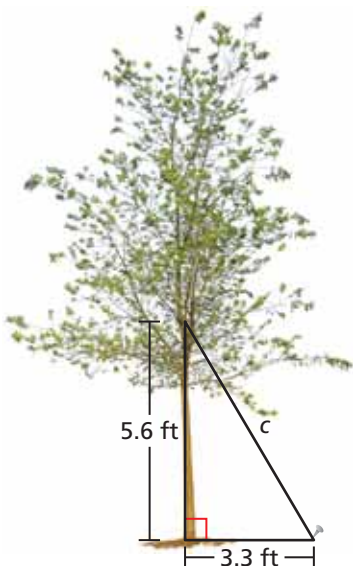
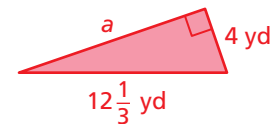

- ERROR ANALYSIS** Describe and correct the error in finding the missing length of the triangle.

X

$$a^2 + b^2 = c^2$$

$$7^2 + 25^2 = c^2$$

$$674 = c^2$$

$$\sqrt{674} = c$$

- TREE SUPPORT** How long is the wire that supports the tree?



Find the missing length of the figure.

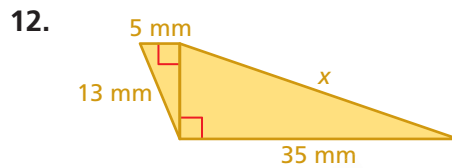
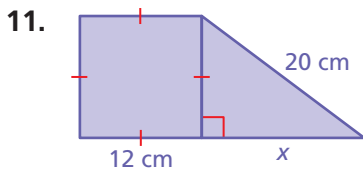

13. **GOLF** The figure shows the location of a golf ball after a tee shot. How many feet from the hole is the ball?

14. **TENNIS** A tennis player asks the referee a question. The sound of the player's voice travels only 30 feet. Can the referee hear the question? Explain.

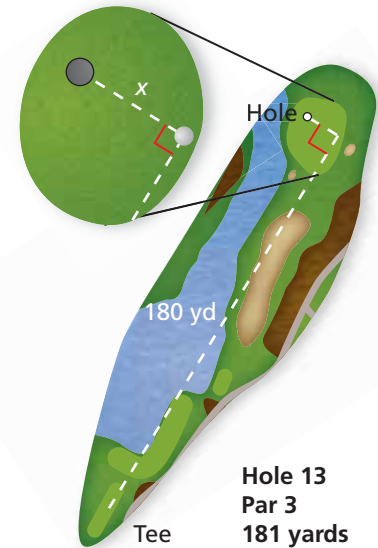
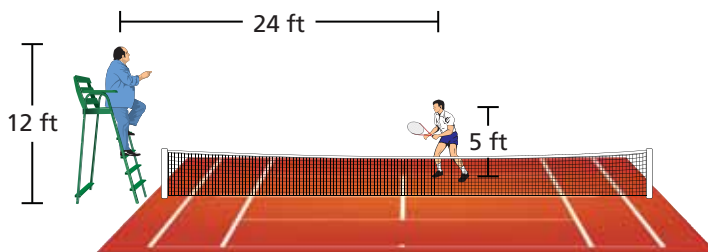

15. **PROJECT** Measure the length, width, and height of a rectangular room. Use the Pythagorean Theorem to find length  $BC$  and length  $AB$ .

16. **ALGEBRA** The legs of a right triangle have lengths of 28 meters and 21 meters. The hypotenuse has a length of  $5x$  meters. What is the value of  $x$ ?

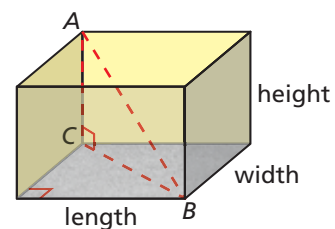

17. **SNOWBALLS** You and a friend stand back-to-back. You run 20 feet forward, then 15 feet to your right. At the same time, your friend runs 16 feet forward, then 12 feet to her right. She stops and hits you with a snowball.

- Draw the situation in a coordinate plane.
- How far does your friend throw the snowball?

18. **Precision** A box has a length of 6 inches, a width of 8 inches, and a height of 24 inches. Can a cylindrical rod with a length of 63.5 centimeters fit in the box? Explain your reasoning.



## Fair Game Review What you learned in previous grades & lessons

Find the square root(s). (Section 7.1)

19.  $\pm\sqrt{36}$

20.  $-\sqrt{121}$

21.  $\sqrt{169}$

22.  $-\sqrt{225}$

23. **MULTIPLE CHOICE** What is the solution of the system of linear equations  $y = 4x + 1$  and  $2x + y = 13$ ? (Section 5.2)

(A)  $x = 1, y = 5$

(B)  $x = 5, y = 3$

(C)  $x = 2, y = 9$

(D)  $x = 9, y = 2$

You can use a **four square** to organize information about a topic. Each of the four squares can be a category, such as *definition*, *vocabulary*, *example*, *non-example*, *words*, *algebra*, *table*, *numbers*, *visual*, *graph*, or *equation*. Here is an example of a four square for the Pythagorean Theorem.

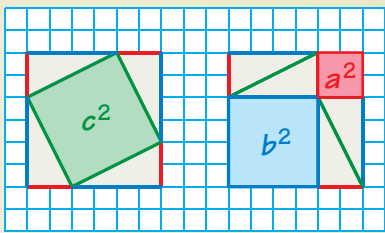
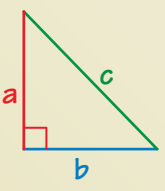
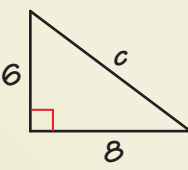
<p style="text-align: center;"><b>Definition</b></p> <p>In any right triangle, the sum of the squares of the lengths of the legs is equal to the square of the length of the hypotenuse.</p>	<p style="text-align: center;"><b>Visual</b></p> 
<p><b>Pythagorean Theorem</b></p>	
<p style="text-align: center;"><b>Algebra</b></p>  <p style="text-align: center;"><math>a^2 + b^2 = c^2</math></p>	<p style="text-align: center;"><b>Example</b></p>  <p style="text-align: right;"> <math>6^2 + 8^2 = c^2</math>  <math>36 + 64 = c^2</math>  <math>100 = c^2</math>  <math>10 = c</math> </p>

## On Your Own

Make four squares to help you study these topics.

1. square roots
2. cube roots

After you complete this chapter, make four squares for the following topics.

3. irrational numbers
4. real numbers
5. converse of the Pythagorean Theorem
6. distance formula



"I'm taking a survey for my **four square**. How many fleas do you have?"

# 7.1–7.3 Quiz

Find the square root(s). (Section 7.1)

1.  $-\sqrt{4}$

2.  $\sqrt{\frac{16}{25}}$

3.  $\pm\sqrt{6.25}$

Find the cube root. (Section 7.2)

4.  $\sqrt[3]{64}$

5.  $\sqrt[3]{-216}$

6.  $\sqrt[3]{-\frac{343}{1000}}$

Evaluate the expression. (Section 7.1 and Section 7.2)

7.  $3\sqrt{49} + 5$

8.  $10 - 4\sqrt{16}$

9.  $\frac{1}{4} + \sqrt{\frac{100}{4}}$

10.  $(\sqrt[3]{-27})^3 + 61$

11.  $15 + 3\sqrt[3]{125}$

12.  $2\sqrt[3]{-729} - 5$

Find the missing length of the triangle. (Section 7.3)

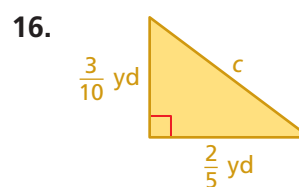
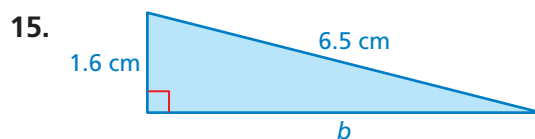
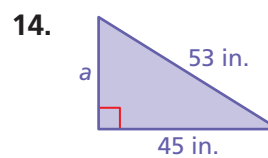
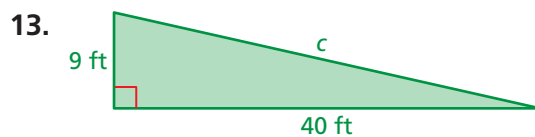

17. **POOL** The area of a circular pool cover is 314 square feet. Write and solve an equation to find the diameter of the pool cover. Use 3.14 for  $\pi$ . (Section 7.1)

18. **PACKAGE** A cube-shaped package has a volume of 5832 cubic inches. What is the edge length of the package? (Section 7.2)



19. **FABRIC** You are cutting a rectangular piece of fabric in half along the diagonal. The fabric measures 28 inches wide and  $1\frac{1}{4}$  yards long. What is the length (in inches) of the diagonal? (Section 7.3)

## 7.4 Approximating Square Roots

**Essential Question** How can you find decimal approximations of square roots that are not rational?

### 1 ACTIVITY: Approximating Square Roots

Work with a partner. Archimedes was a Greek mathematician, physicist, engineer, inventor, and astronomer. He tried to find a rational number whose square is 3. Two that he tried were  $\frac{265}{153}$  and  $\frac{1351}{780}$ .

- Are either of these numbers equal to  $\sqrt{3}$ ? Explain.
- Use a calculator to approximate  $\sqrt{3}$ . Write the number on a piece of paper. Enter it into the calculator and square it. Then subtract 3. Do you get 0? What does this mean?
- The value of  $\sqrt{3}$  is between which two integers?
- Tell whether the value of  $\sqrt{3}$  is between the given numbers. Explain your reasoning.

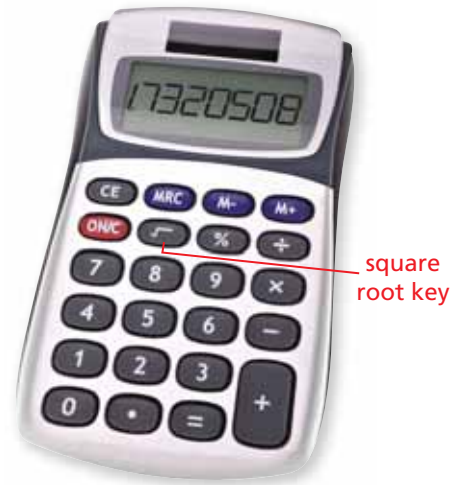

1.7 and 1.8

1.72 and 1.73

1.731 and 1.732

### 2 ACTIVITY: Approximating Square Roots Geometrically

Work with a partner. Refer to the square on the number line below.

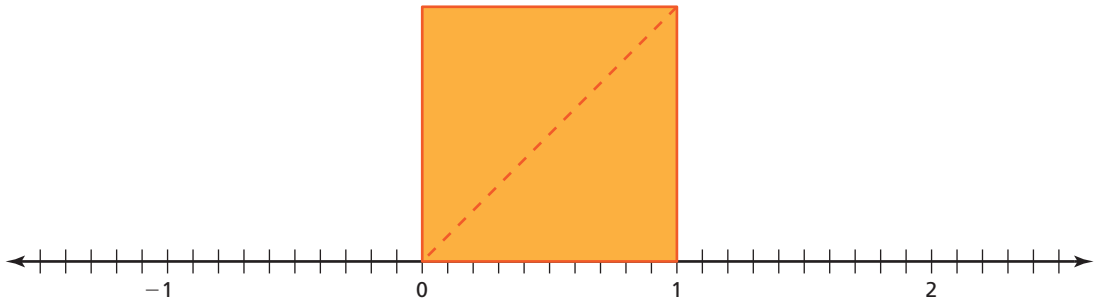

- What is the length of the diagonal of the square?
- Copy the square and its diagonal onto a piece of transparent paper. Rotate it about zero on the number line so that the diagonal aligns with the number line. Use the number line to estimate the length of the diagonal.
- STRUCTURE** How do you think your answers in parts (a) and (b) are related?



#### Square Roots

In this lesson, you will

- define irrational numbers.
- approximate square roots.
- approximate values of expressions involving irrational numbers.

Learning Standards

- 8.NS.1
- 8.NS.2
- 8.EE.2

### 3 ACTIVITY: Approximating Square Roots Geometrically

#### Math Practice 5

##### Recognize Usefulness of Tools

Why is the Pythagorean Theorem a useful tool when approximating a square root?

Work with a partner.

- Use grid paper and the given scale to draw a horizontal line segment 1 unit in length. Label this segment  $AC$ .
- Draw a vertical line segment 2 units in length. Label this segment  $DC$ .
- Set the point of a compass on  $A$ . Set the compass to 2 units. Swing the compass to intersect segment  $DC$ . Label this intersection as  $B$ .
- Use the Pythagorean Theorem to find the length of segment  $BC$ .
- Use the grid paper to approximate  $\sqrt{3}$  to the nearest tenth.

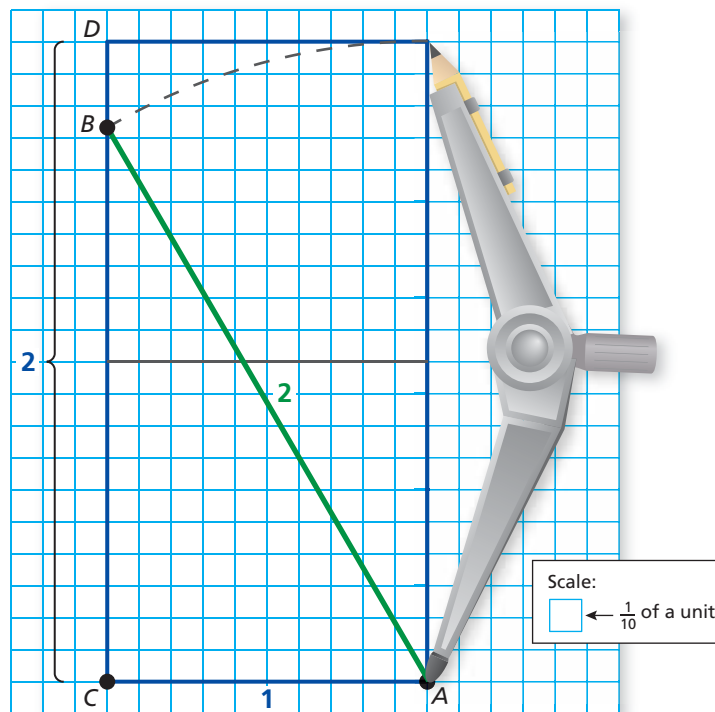

### What Is Your Answer?

- Compare your approximation in Activity 3 with your results from Activity 1.
- Repeat Activity 3 for a triangle in which segment  $AC$  is 2 units and segment  $BA$  is 3 units. Use the Pythagorean Theorem to find the length of segment  $BC$ . Use the grid paper to approximate  $\sqrt{5}$  to the nearest tenth.
- IN YOUR OWN WORDS** How can you find decimal approximations of square roots that are not rational?

#### Practice

Use what you learned about approximating square roots to complete Exercises 5–8 on page 313.



### Key Vocabulary

irrational number,  
p. 310  
real numbers, p. 310

A rational number is a number that can be written as the ratio of two integers. An **irrational number** cannot be written as the ratio of two integers.

- The square root of any whole number that is not a perfect square is irrational. The cube root of any integer that is not a perfect cube is irrational.
- The decimal form of an irrational number neither terminates nor repeats.

## Key Idea

### Real Numbers

Rational numbers and irrational numbers together form the set of **real numbers**.

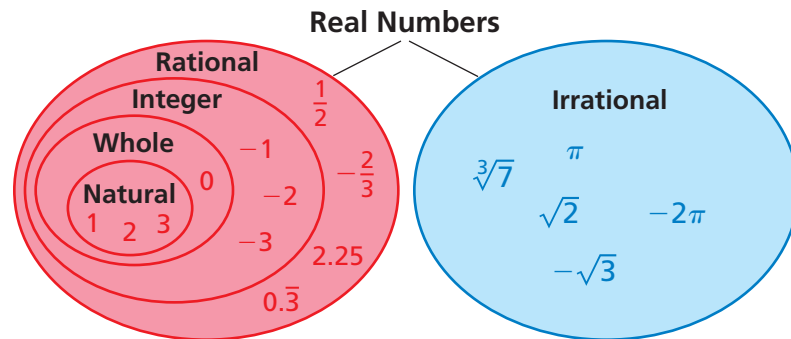

### Remember

The decimal form of a rational number either terminates or repeats.

## EXAMPLE 1 Classifying Real Numbers

Classify each real number.

Number	Subset(s)	Reasoning
a. $\sqrt{12}$	Irrational	12 is not a perfect square.
b. $-0.\overline{25}$	Rational	$-0.\overline{25}$ is a repeating decimal.
c. $-\sqrt{9}$	Integer, Rational	$-\sqrt{9}$ is equal to $-3$ .
d. $\frac{72}{4}$	Natural, Whole, Integer, Rational	$\frac{72}{4}$ is equal to 18.
e. $\pi$	Irrational	The decimal form of $\pi$ neither terminates nor repeats.

### Study Tip

When classifying a real number, list all the subsets in which the number belongs.

## On Your Own

Classify the real number.

1.  $0.121221222\dots$
2.  $-\sqrt{196}$
3.  $\sqrt[3]{2}$

Now You're Ready  
Exercises 9–16

## EXAMPLE 2 Approximating a Square Root

Estimate  $\sqrt{71}$  to the nearest (a) integer and (b) tenth.

- a. Make a table of numbers whose squares are close to 71.

Number	7	8	9	10
Square of Number	49	64	81	100

The table shows that 71 is between the perfect squares 64 and 81. Because 71 is closer to 64 than to 81,  $\sqrt{71}$  is closer to 8 than to 9.

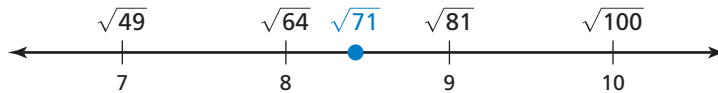

So,  $\sqrt{71} \approx 8$ .

- b. Make a table of numbers between 8 and 9 whose squares are close to 71.

Number	8.3	8.4	8.5	8.6
Square of Number	68.89	70.56	72.25	73.96

Because 71 is closer to 70.56 than to 72.25,  $\sqrt{71}$  is closer to 8.4 than to 8.5.

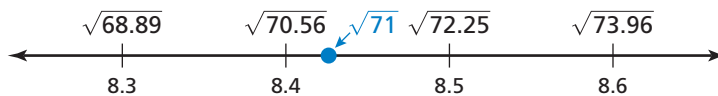

So,  $\sqrt{71} \approx 8.4$ .

### Study Tip

You can continue the process shown in Example 2 to approximate square roots using more decimal places.

### On Your Own

Now You're Ready  
Exercises 20–25

Estimate the square root to the nearest (a) integer and (b) tenth.

4.  $\sqrt{8}$       5.  $-\sqrt{13}$       6.  $-\sqrt{24}$       7.  $\sqrt{110}$

## EXAMPLE 3 Comparing Real Numbers

Which is greater,  $\sqrt{5}$  or  $2\frac{2}{3}$ ?

Estimate  $\sqrt{5}$  to the nearest integer. Then graph the numbers on a number line.

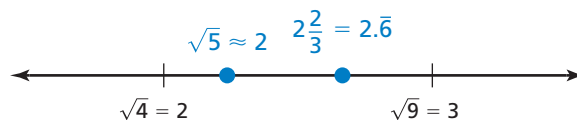

$2\frac{2}{3}$  is to the right of  $\sqrt{5}$ . So,  $2\frac{2}{3}$  is greater.

## EXAMPLE 4 Approximating the Value of an Expression

The radius of a circle with area  $A$  is approximately  $\sqrt{\frac{A}{3}}$ . The area of a circular mouse pad is 51 square inches. Estimate its radius to the nearest integer.



$$\begin{aligned}\sqrt{\frac{A}{3}} &= \sqrt{\frac{51}{3}} && \text{Substitute 51 for } A. \\ &= \sqrt{17} && \text{Divide.}\end{aligned}$$

The nearest perfect square less than 17 is 16. The nearest perfect square greater than 17 is 25.

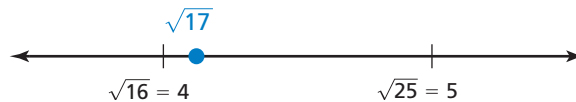

Because 17 is closer to 16 than to 25,  $\sqrt{17}$  is closer to 4 than to 5.

∴ So, the radius is about 4 inches.

## EXAMPLE 5 Real-Life Application

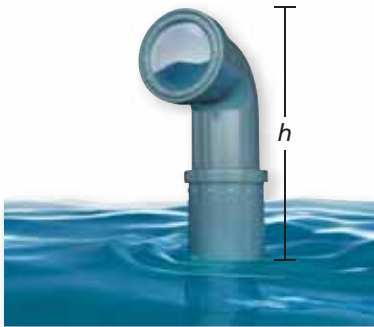

The distance (in nautical miles) you can see with a periscope is  $1.17\sqrt{h}$ , where  $h$  is the height of the periscope above the water. Can you see twice as far with a periscope that is 6 feet above the water than with a periscope that is 3 feet above the water? Explain.

Use a calculator to find the distances.

**3 Feet Above Water**

$$\begin{aligned}1.17\sqrt{h} &= 1.17\sqrt{3} && \text{Substitute for } h. \\ &\approx 2.03 && \text{Use a calculator.}\end{aligned}$$

**6 Feet Above Water**

$$\begin{aligned}1.17\sqrt{h} &= 1.17\sqrt{6} \\ &\approx 2.87\end{aligned}$$

You can see  $\frac{2.87}{2.03} \approx 1.41$  times farther with the periscope that is 6 feet above the water than with the periscope that is 3 feet above the water.

∴ No, you cannot see twice as far with the periscope that is 6 feet above the water.

### On Your Own

Which number is greater? Explain.

8.  $4\frac{1}{5}, \sqrt{23}$       9.  $\sqrt{10}, -\sqrt{5}$       10.  $-\sqrt{2}, -2$

11. The area of a circular mouse pad is 64 square inches. Estimate its radius to the nearest integer.

12. In Example 5, you use a periscope that is 10 feet above the water. Can you see farther than 4 nautical miles? Explain.

```
1.17√(3)
2.026499445
1.17√(6)
2.865902999
```

Now You're Ready  
Exercises 26–31

## Vocabulary and Concept Check

- VOCABULARY** How are rational numbers and irrational numbers different?
- WRITING** Describe a method of approximating  $\sqrt{32}$ .
- VOCABULARY** What are real numbers? Give three examples.
- WHICH ONE DOESN'T BELONG?** Which number does *not* belong with the other three? Explain your reasoning.

$$-\frac{11}{12}$$

$$25.075$$

$$\sqrt{8}$$

$$-3.\bar{3}$$

## Practice and Problem Solving

Tell whether the rational number is a reasonable approximation of the square root.

5.  $\frac{559}{250}, \sqrt{5}$

6.  $\frac{3021}{250}, \sqrt{11}$

7.  $\frac{678}{250}, \sqrt{28}$

8.  $\frac{1677}{250}, \sqrt{45}$

Classify the real number.

1 9. 0

10.  $\sqrt[3]{343}$

11.  $\frac{\pi}{6}$

12.  $-\sqrt{81}$

13.  $-1.125$

14.  $\frac{52}{13}$

15.  $\sqrt[3]{-49}$

16.  $\sqrt{15}$

17. **ERROR ANALYSIS** Describe and correct the error in classifying the number.

**X**  $\sqrt{144}$  is irrational.

18. **SCRAPBOOKING** You cut a picture into a right triangle for your scrapbook. The lengths of the legs of the triangle are 4 inches and 6 inches. Is the length of the hypotenuse a rational number? Explain.

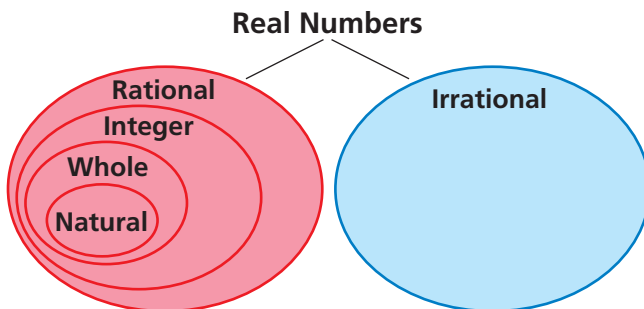

19. **VENN DIAGRAM** Place each number in the correct area of the Venn Diagram.

- the last digit of your phone number
- the square root of any prime number
- the ratio of the circumference of a circle to its diameter

Estimate the square root to the nearest (a) integer and (b) tenth.

2 20.  $\sqrt{46}$

21.  $\sqrt{685}$

22.  $-\sqrt{61}$

23.  $-\sqrt{105}$

24.  $\sqrt{\frac{27}{4}}$

25.  $-\sqrt{\frac{335}{2}}$

Which number is greater? Explain.

26.  $\sqrt{20}$ , 10

27.  $\sqrt{15}$ ,  $-3.5$

28.  $\sqrt{133}$ ,  $10\frac{3}{4}$

29.  $\frac{2}{3}$ ,  $\sqrt{\frac{16}{81}}$

30.  $-\sqrt{0.25}$ ,  $-0.25$

31.  $-\sqrt{182}$ ,  $-\sqrt{192}$

Use the graphing calculator screen to determine whether the statement is *true* or *false*.

32. To the nearest tenth,  $\sqrt{10} = 3.1$ .

33. The value of  $\sqrt{14}$  is between 3.74 and 3.75.

34.  $\sqrt{10}$  lies between 3.1 and 3.16 on a number line.

```
√(10)
3.16227766
√(14)
3.741657387
```

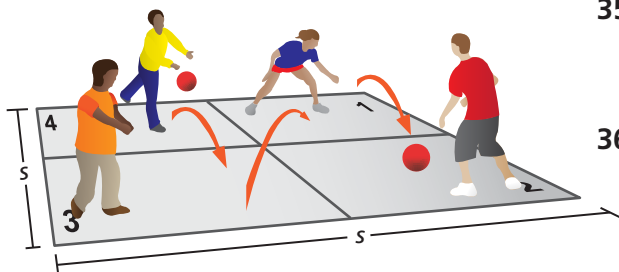

35. **FOUR SQUARE** The area of a four square court is 66 square feet. Estimate the side length  $s$  to the nearest tenth of a foot.

36. **CHECKERS** A checkers board is 8 squares long and 8 squares wide. The area of each square is 14 square centimeters. Estimate the perimeter of the checkers board to the nearest tenth of a centimeter.

Approximate the length of the diagonal of the square or rectangle to the nearest tenth.

37.

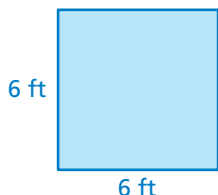

38.



39.



40. **WRITING** Explain how to continue the method in Example 2 to estimate  $\sqrt{71}$  to the nearest hundredth.

41. **REPEATED REASONING** Describe a method that you can use to estimate a cube root to the nearest tenth. Use your method to estimate  $\sqrt[3]{14}$  to the nearest tenth.

42. **RADIO SIGNAL** The maximum distance (in nautical miles) that a radio transmitter signal can be sent is represented by the expression  $1.23\sqrt{h}$ , where  $h$  is the height (in feet) above the transmitter.

Estimate the maximum distance  $x$  (in nautical miles) between the plane that is receiving the signal and the transmitter. Round your answer to the nearest tenth.

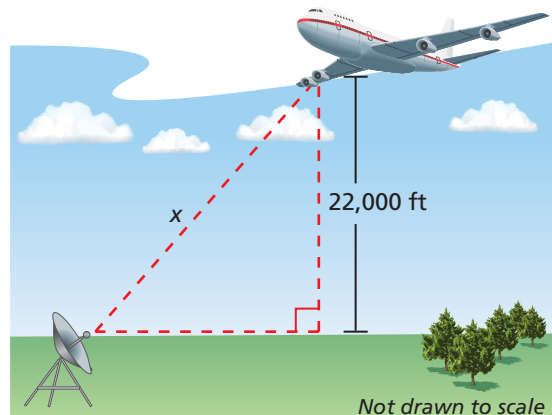

43. **OPEN-ENDED** Find two numbers  $a$  and  $b$  that satisfy the diagram.

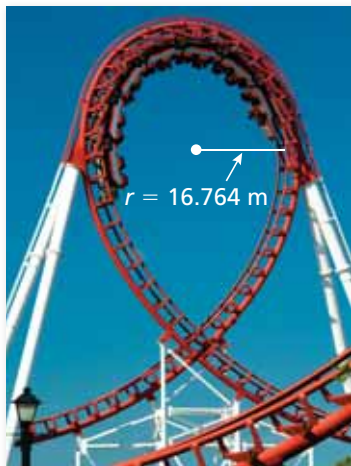

**Estimate the square root to the nearest tenth.**

44.  $\sqrt{0.39}$       45.  $\sqrt{1.19}$       46.  $\sqrt{1.52}$

47. **ROLLER COASTER** The speed  $s$  (in meters per second) of a roller-coaster car is approximated by the equation  $s = 3\sqrt{6r}$ , where  $r$  is the radius of the loop. Estimate the speed of a car going around the loop. Round your answer to the nearest tenth.

48. **STRUCTURE** Is  $\sqrt{\frac{1}{4}}$  a rational number? Is  $\sqrt{\frac{3}{16}}$  a rational number? Explain.

49. **WATER BALLOON** The time  $t$  (in seconds) it takes a water balloon to fall  $d$  meters is represented by the equation  $t = \sqrt{\frac{d}{4.9}}$ . Estimate the time it takes the balloon to fall to the ground from a window that is 14 meters above the ground. Round your answer to the nearest tenth.



50. **Number Sense** Determine if the statement is *sometimes*, *always*, or *never* true. Explain your reasoning and give an example of each.
- A rational number multiplied by a rational number is rational.
  - A rational number multiplied by an irrational number is rational.
  - An irrational number multiplied by an irrational number is rational.



## Fair Game Review what you learned in previous grades & lessons

Find the missing length of the triangle. (Section 7.3)

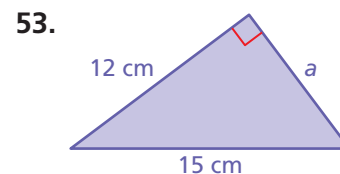
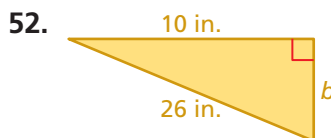
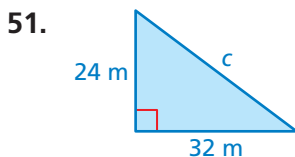

54. **MULTIPLE CHOICE** What is the ratio (red to blue) of the corresponding side lengths of the similar triangles? (Section 2.5)

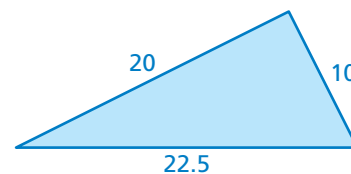
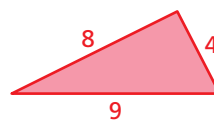

- (A) 1:3      (B) 5:2  
(C) 3:4      (D) 2:5

You have written terminating decimals as fractions. Because repeating decimals are rational numbers, you can also write repeating decimals as fractions.

### Key Idea

#### Writing a Repeating Decimal as a Fraction

Let a variable  $x$  equal the repeating decimal  $d$ .

**Step 1:** Write the equation  $x = d$ .

**Step 2:** Multiply each side of the equation by  $10^n$  to form a new equation, where  $n$  is the number of repeating digits.

**Step 3:** Subtract the original equation from the new equation.

**Step 4:** Solve for  $x$ .



COMMON  
CORE

Rational Numbers

In this extension, you will

- write a repeating decimal as a fraction.

Learning Standard  
8.NS.1

### EXAMPLE 1 Writing a Repeating Decimal as a Fraction (1 Digit Repeats)

Write  $0.\overline{4}$  as a fraction in simplest form.

Let  $x = 0.\overline{4}$ .

$$x = 0.\overline{4}$$

Step 1: Write the equation.

$$10 \cdot x = 10 \cdot 0.\overline{4}$$

Step 2: There is 1 repeating digit, so multiply each side by  $10^1 = 10$ .

$$10x = 4.\overline{4}$$

Simplify.

$$\underline{-(x = 0.\overline{4})}$$

Step 3: Subtract the original equation.

$$9x = 4$$

Simplify.

$$x = \frac{4}{9}$$

Step 4: Solve for  $x$ .

$$\therefore \text{So, } 0.\overline{4} = \frac{4}{9}$$

#### Check

$$\begin{array}{r} 0.44 \dots \\ 9 \overline{)4.00} \quad \checkmark \\ \underline{36} \phantom{00} \\ 40 \phantom{00} \\ \underline{36} \phantom{00} \\ 40 \phantom{00} \end{array}$$

### Practice

Write the decimal as a fraction or a mixed number.

1.  $0.\overline{1}$

2.  $-0.\overline{5}$

3.  $-1.\overline{2}$

4.  $5.\overline{8}$

- STRUCTURE** In Example 1, why can you subtract the original equation from the new equation after multiplying by 10? Explain why these two steps are performed.
- REPEATED REASONING** Compare the repeating decimals and their equivalent fractions in Exercises 1–4. Describe the pattern. Use the pattern to explain how to write a repeating decimal as a fraction when only the tenths digit repeats.



## EXAMPLE 2 Writing a Repeating Decimal as a Fraction (1 Digit Repeats)

Write  $-0.2\bar{3}$  as a fraction in simplest form.

Let  $x = -0.2\bar{3}$ .

$$x = -0.2\bar{3}$$

Step 1: Write the equation.

$$10 \cdot x = 10 \cdot (-0.2\bar{3})$$

Step 2: There is 1 repeating digit, so multiply each side by  $10^1 = 10$ .

$$10x = -2.\bar{3}$$

Simplify.

$$\underline{- (x = -0.2\bar{3})}$$

Step 3: Subtract the original equation.

$$9x = -2.1$$

Simplify.

$$x = \frac{-2.1}{9}$$

Step 4: Solve for  $x$ .

Check

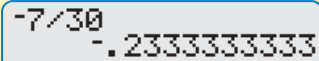

$$\therefore \text{ So, } -0.2\bar{3} = \frac{-2.1}{9} = \frac{-21}{90} = \frac{-7}{30}.$$

## EXAMPLE 3 Writing a Repeating Decimal as a Fraction (2 Digits Repeat)

Write  $1.2\bar{5}$  as a mixed number.

Let  $x = 1.2\bar{5}$ .

$$x = 1.2\bar{5}$$

Step 1: Write the equation.

$$100 \cdot x = 100 \cdot 1.2\bar{5}$$

Step 2: There are 2 repeating digits, so multiply each side by  $10^2 = 100$ .

$$100x = 125.\bar{25}$$

Simplify.

$$\underline{- (x = 1.2\bar{5})}$$

Step 3: Subtract the original equation.

$$99x = 124$$

Simplify.

$$x = \frac{124}{99}$$

Step 4: Solve for  $x$ .

Check

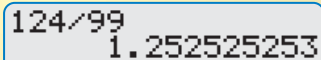

$$\therefore \text{ So, } 1.2\bar{5} = \frac{124}{99} = 1\frac{25}{99}.$$

### Practice

Write the decimal as a fraction or a mixed number.

7.  $-0.4\bar{3}$

8.  $2.0\bar{6}$

9.  $0.2\bar{7}$

10.  $-4.5\bar{0}$

11. **REPEATED REASONING** Find a pattern in the fractional representations of repeating decimals in which only the tenths and hundredths digits repeat. Use the pattern to explain how to write  $9.0\bar{4}$  as a mixed number.

# 7.5 Using the Pythagorean Theorem

**Essential Question** In what other ways can you use the Pythagorean Theorem?

The *converse* of a statement switches the hypothesis and the conclusion.

Statement:  
If  $p$ , then  $q$ .

Converse of the statement:  
If  $q$ , then  $p$ .

## 1 ACTIVITY: Analyzing Converses of Statements

Work with a partner. Write the converse of the true statement. Determine whether the converse is *true* or *false*. If it is true, justify your reasoning. If it is false, give a counterexample.

- If  $a = b$ , then  $a^2 = b^2$ .
- If  $a = b$ , then  $a^3 = b^3$ .
- If one figure is a translation of another figure, then the figures are congruent.
- If two triangles are similar, then the triangles have the same angle measures.

Is the converse of a true statement always true? always false? Explain.

## 2 ACTIVITY: The Converse of the Pythagorean Theorem

Work with a partner. The converse of the Pythagorean Theorem states: “If the equation  $a^2 + b^2 = c^2$  is true for the side lengths of a triangle, then the triangle is a right triangle.”

- Do you think the converse of the Pythagorean Theorem is *true* or *false*? How could you use deductive reasoning to support your answer?
- Consider  $\triangle DEF$  with side lengths  $a$ ,  $b$ , and  $c$ , such that  $a^2 + b^2 = c^2$ . Also consider  $\triangle JKL$  with leg lengths  $a$  and  $b$ , where  $\angle K = 90^\circ$ .
  - What does the Pythagorean Theorem tell you about  $\triangle JKL$ ?
  - What does this tell you about  $c$  and  $x$ ?
  - What does this tell you about  $\triangle DEF$  and  $\triangle JKL$ ?
  - What does this tell you about  $\angle E$ ?
  - What can you conclude?

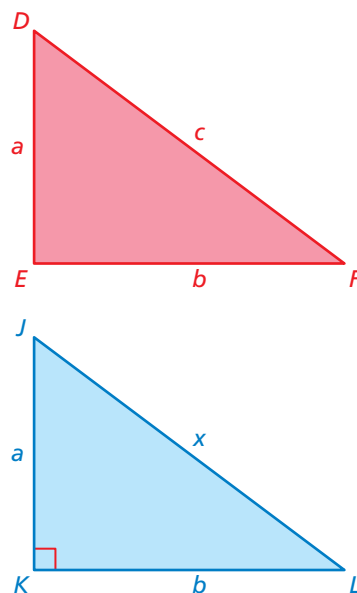

COMMON  
CORE

### Pythagorean Theorem

In this lesson, you will

- use the converse of the Pythagorean Theorem to identify right triangles.
- use the Pythagorean Theorem to find distances in a coordinate plane.
- solve real-life problems.

Learning Standards

- 8.EE.2
- 8.G.6
- 8.G.7
- 8.G.8

### 3 ACTIVITY: Developing the Distance Formula

Work with a partner. Follow the steps below to write a formula that you can use to find the distance between any two points in a coordinate plane.

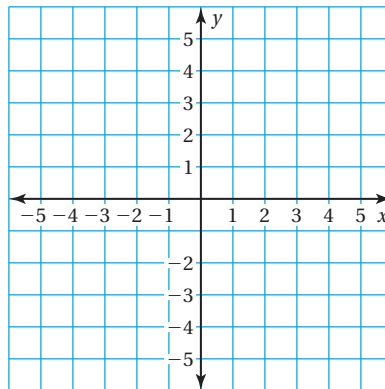
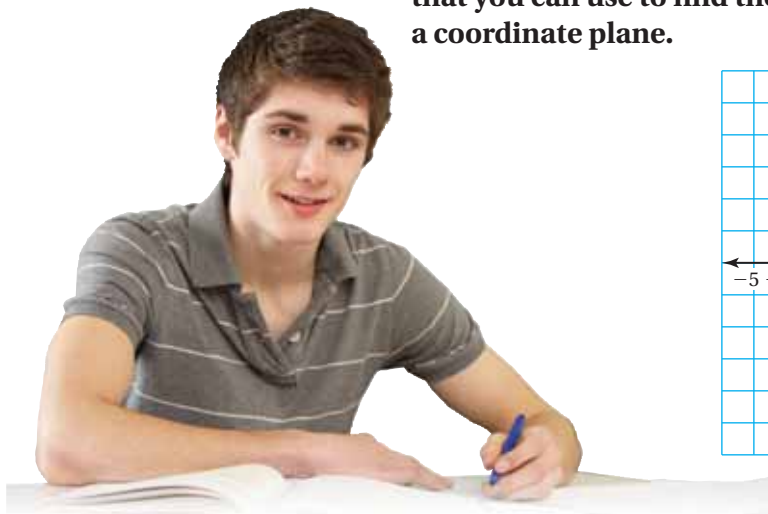

#### Math Practice 6

##### Communicate Precisely

What steps can you take to make sure that you have written the distance formula accurately?

- Step 1:** Choose two points in the coordinate plane that do not lie on the same horizontal or vertical line. Label the points  $(x_1, y_1)$  and  $(x_2, y_2)$ .
- Step 2:** Draw a line segment connecting the points. This will be the hypotenuse of a right triangle.
- Step 3:** Draw horizontal and vertical line segments from the points to form the legs of the right triangle.
- Step 4:** Use the  $x$ -coordinates to write an expression for the length of the horizontal leg.
- Step 5:** Use the  $y$ -coordinates to write an expression for the length of the vertical leg.
- Step 6:** Substitute the expressions for the lengths of the legs into the Pythagorean Theorem.
- Step 7:** Solve the equation in Step 6 for the hypotenuse  $c$ .

What does the length of the hypotenuse tell you about the two points?

### What Is Your Answer?

4. **IN YOUR OWN WORDS** In what other ways can you use the Pythagorean Theorem?
5. What kind of real-life problems do you think the converse of the Pythagorean Theorem can help you solve?

#### Practice

Use what you learned about the converse of a true statement to complete Exercises 3 and 4 on page 322.

## Key Vocabulary

distance formula,  
p. 320

## Key Ideas

### Converse of the Pythagorean Theorem

If the equation  $a^2 + b^2 = c^2$  is true for the side lengths of a triangle, then the triangle is a right triangle.

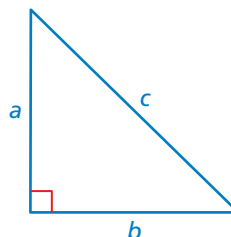

## EXAMPLE 1 Identifying a Right Triangle

### Study Tip

A *Pythagorean triple* is a set of three positive integers  $a$ ,  $b$ , and  $c$ , where  $a^2 + b^2 = c^2$ .

### Common Error

When using the converse of the Pythagorean Theorem, always substitute the length of the longest side for  $c$ .

Tell whether each triangle is a right triangle.

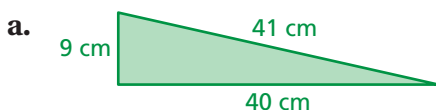

$$a^2 + b^2 = c^2$$

$$9^2 + 40^2 \stackrel{?}{=} 41^2$$

$$81 + 1600 \stackrel{?}{=} 1681$$

$$1681 = 1681 \quad \checkmark$$

∴ It is a right triangle.

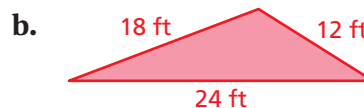

$$a^2 + b^2 = c^2$$

$$12^2 + 18^2 \stackrel{?}{=} 24^2$$

$$144 + 324 \stackrel{?}{=} 576$$

$$468 \neq 576 \quad \times$$

∴ It is *not* a right triangle.

### On Your Own

Tell whether the triangle with the given side lengths is a right triangle.

1. 28 in., 21 in., 20 in.

2. 1.25 mm, 1 mm, 0.75 mm

Now You're Ready  
Exercises 5–10

On page 319, you used the Pythagorean Theorem to develop the *distance formula*. You can use the **distance formula** to find the distance between any two points in a coordinate plane.

## Key Idea

### Distance Formula

The distance  $d$  between any two points  $(x_1, y_1)$  and  $(x_2, y_2)$  is given by the formula

$$d = \sqrt{(x_2 - x_1)^2 + (y_2 - y_1)^2}$$

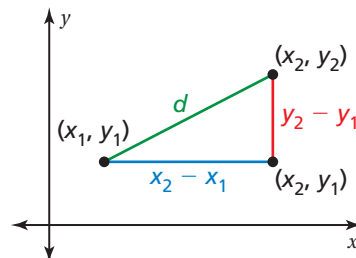

## EXAMPLE 2 Finding the Distance Between Two Points

Find the distance between  $(1, 5)$  and  $(-4, -2)$ .

Let  $(x_1, y_1) = (1, 5)$  and  $(x_2, y_2) = (-4, -2)$ .

$$\begin{aligned}d &= \sqrt{(x_2 - x_1)^2 + (y_2 - y_1)^2} && \text{Write the distance formula.} \\&= \sqrt{(-4 - 1)^2 + (-2 - 5)^2} && \text{Substitute.} \\&= \sqrt{(-5)^2 + (-7)^2} && \text{Simplify.} \\&= \sqrt{25 + 49} && \text{Evaluate powers.} \\&= \sqrt{74} && \text{Add.}\end{aligned}$$

## EXAMPLE 3 Real-Life Application

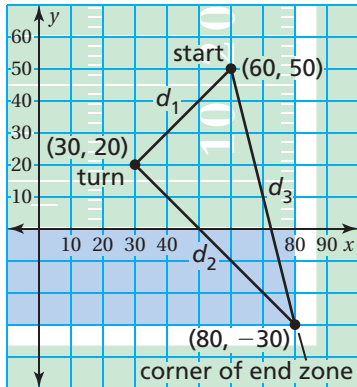

You design a football play in which a player runs down the field, makes a  $90^\circ$  turn, and runs to the corner of the end zone. Your friend runs the play as shown. Did your friend make a  $90^\circ$  turn? Each unit of the grid represents 10 feet.

Use the distance formula to find the lengths of the three sides.

$$\begin{aligned}d_1 &= \sqrt{(60 - 30)^2 + (50 - 20)^2} = \sqrt{30^2 + 30^2} = \sqrt{1800} \text{ feet} \\d_2 &= \sqrt{(80 - 30)^2 + (-30 - 20)^2} = \sqrt{50^2 + (-50)^2} = \sqrt{5000} \text{ feet} \\d_3 &= \sqrt{(80 - 60)^2 + (-30 - 50)^2} = \sqrt{20^2 + (-80)^2} = \sqrt{6800} \text{ feet}\end{aligned}$$

Use the converse of the Pythagorean Theorem to determine if the side lengths form a right triangle.

$$\begin{aligned}(\sqrt{1800})^2 + (\sqrt{5000})^2 &\stackrel{?}{=} (\sqrt{6800})^2 \\1800 + 5000 &\stackrel{?}{=} 6800 \\6800 &= 6800 \quad \checkmark\end{aligned}$$

The sides form a right triangle.

∴ So, your friend made a  $90^\circ$  turn.

### On Your Own

Find the distance between the two points.

- $(0, 0)$ ,  $(4, 5)$
- $(7, -3)$ ,  $(9, 6)$
- $(-2, -3)$ ,  $(-5, 1)$
- WHAT IF?** In Example 3, your friend made the turn at  $(20, 10)$ . Did your friend make a  $90^\circ$  turn?

Now You're Ready  
Exercises 11–16

**Vocabulary and Concept Check**

- WRITING** Describe two ways to find the distance between two points in a coordinate plane.
- WHICH ONE DOESN'T BELONG?** Which set of numbers does *not* belong with the other three? Explain your reasoning.

3, 6, 8

6, 8, 10

5, 12, 13

7, 24, 25

**Practice and Problem Solving**

Write the converse of the true statement. Determine whether the converse is *true* or *false*. If it is true, justify your reasoning. If it is false, give a counterexample.

- If  $a$  is an odd number, then  $a^2$  is odd.
- If  $ABCD$  is a square, then  $ABCD$  is a parallelogram.

Tell whether the triangle with the given side lengths is a right triangle.

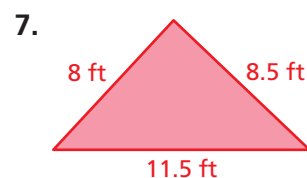
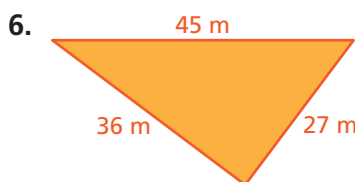
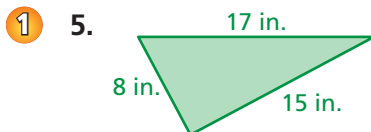

- 14 mm, 19 mm, 23 mm
- $\frac{9}{10}$  mi,  $1\frac{1}{5}$  mi,  $1\frac{1}{2}$  mi
- 1.4 m, 4.8 m, 5 m

Find the distance between the two points.

11. (1, 2), (7, 6)
12. (4, -5), (-1, 7)
13. (2, 4), (7, 2)
14. (-1, -3), (1, 3)
15. (-6, -7), (0, 0)
16. (12, 5), (-12, -2)

- ERROR ANALYSIS** Describe and correct the error in finding the distance between the points  $(-3, -2)$  and  $(7, 4)$ .

 
$$\begin{aligned} d &= \sqrt{[7 - (-3)]^2 - [4 - (-2)]^2} \\ &= \sqrt{100 - 36} \\ &= \sqrt{64} = 8 \end{aligned}$$

- CONSTRUCTION** A post and beam frame for a shed is shown in the diagram. Does the brace form a right triangle with the post and beam? Explain.

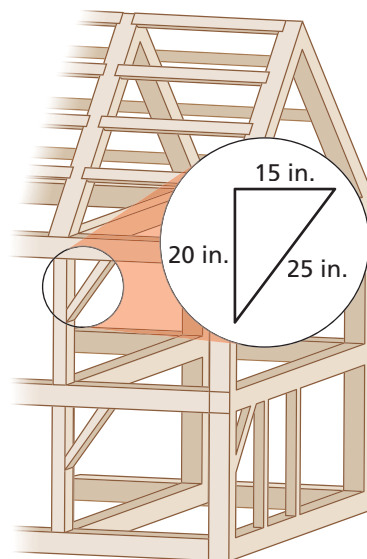

Tell whether a triangle with the given side lengths is a right triangle.

19.  $\sqrt{63}, 9, 12$

20.  $4, \sqrt{15}, 6$

21.  $\sqrt{18}, \sqrt{24}, \sqrt{42}$

22. **REASONING** Plot the points  $(-1, 3)$ ,  $(4, -2)$ , and  $(1, -5)$  in a coordinate plane. Are the points the vertices of a right triangle? Explain.

23. **GEOCACHING** You spend the day looking for hidden containers in a wooded area using a Global Positioning System (GPS). You park your car on the side of the road, and then locate Container 1 and Container 2 before going back to the car. Does your path form a right triangle? Explain. Each unit of the grid represents 10 yards.

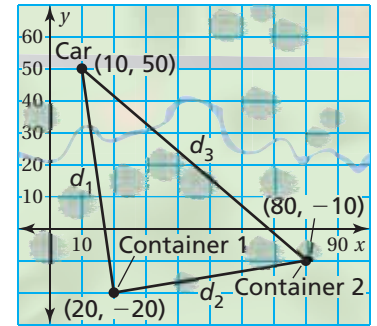

24. **REASONING** Your teacher wants the class to find the distance between the two points  $(2, 4)$  and  $(9, 7)$ . You use  $(2, 4)$  for  $(x_1, y_1)$ , and your friend uses  $(9, 7)$  for  $(x_1, y_1)$ . Do you and your friend obtain the same result? Justify your answer.

25. **AIRPORT** Which plane is closer to the base of the airport tower? Explain.

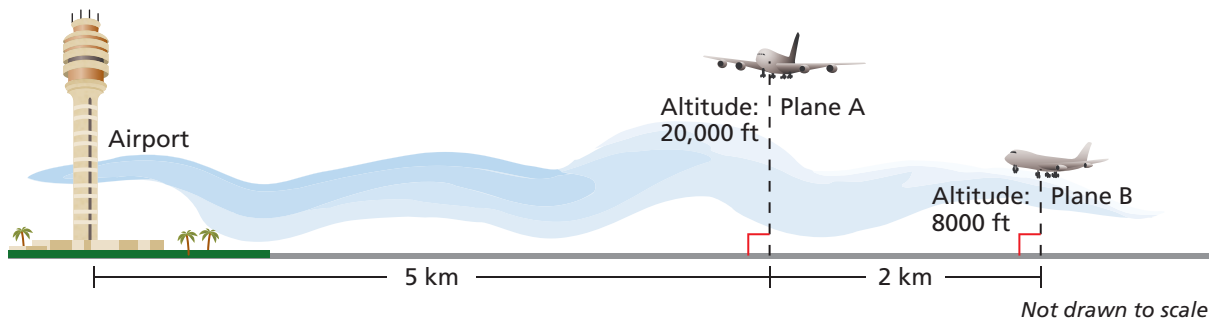

26. **Structure** Consider the two points  $(x_1, y_1)$  and  $(x_2, y_2)$  in the coordinate plane. How can you find the point  $(x_m, y_m)$  located in the middle of the two given points? Justify your answer using the distance formula.

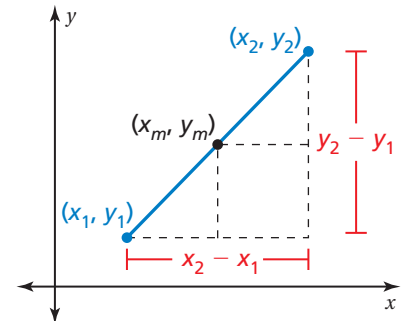

## Fair Game Review what you learned in previous grades & lessons

Find the mean, median, and mode of the data. (*Skills Review Handbook*)

27. 12, 9, 17, 15, 12, 13

28. 21, 32, 16, 27, 22, 19, 10

29. 67, 59, 34, 71, 59

30. **MULTIPLE CHOICE** What is the sum of the interior angle measures of an octagon? (*Section 3.3*)

(A)  $720^\circ$

(B)  $1080^\circ$

(C)  $1440^\circ$

(D)  $1800^\circ$



# 7.4–7.5 Quiz



**Classify the real number.** (Section 7.4)

- |                  |                    |
|------------------|--------------------|
| 1. $-\sqrt{225}$ | 2. $-1\frac{1}{9}$ |
| 3. $\sqrt{41}$   | 4. $\sqrt{17}$     |

**Estimate the square root to the nearest (a) integer and (b) tenth.** (Section 7.4)

- |                 |                 |
|-----------------|-----------------|
| 5. $\sqrt{38}$  | 6. $-\sqrt{99}$ |
| 7. $\sqrt{172}$ | 8. $\sqrt{115}$ |

**Which number is greater? Explain.** (Section 7.4)

- |                              |                               |
|------------------------------|-------------------------------|
| 9. $\sqrt{11}, 3\frac{3}{5}$ | 10. $\sqrt{1.44}, 1.1\bar{8}$ |
|------------------------------|-------------------------------|

**Write the decimal as a fraction or a mixed number.** (Section 7.4)

- |                 |                   |
|-----------------|-------------------|
| 11. $0.\bar{7}$ | 12. $-1.\bar{63}$ |
|-----------------|-------------------|

**Tell whether the triangle with the given side lengths is a right triangle.** (Section 7.5)

13.

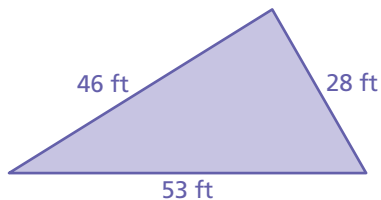

14.

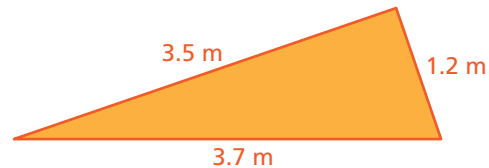

**Find the distance between the two points.** (Section 7.5)

- |                          |                       |
|--------------------------|-----------------------|
| 15. $(-3, -1), (-1, -5)$ | 16. $(-4, 2), (5, 1)$ |
| 17. $(1, -2), (4, -5)$   | 18. $(-1, 1), (7, 4)$ |
| 19. $(-6, 5), (-4, -6)$  | 20. $(-1, 4), (1, 3)$ |

**Use the figure to answer Exercises 21–24. Round your answer to the nearest tenth.** (Section 7.5)

21. How far is the cabin from the peak?
22. How far is the fire tower from the lake?
23. How far is the lake from the peak?
24. You are standing at  $(-5, -6)$ . How far are you from the lake?

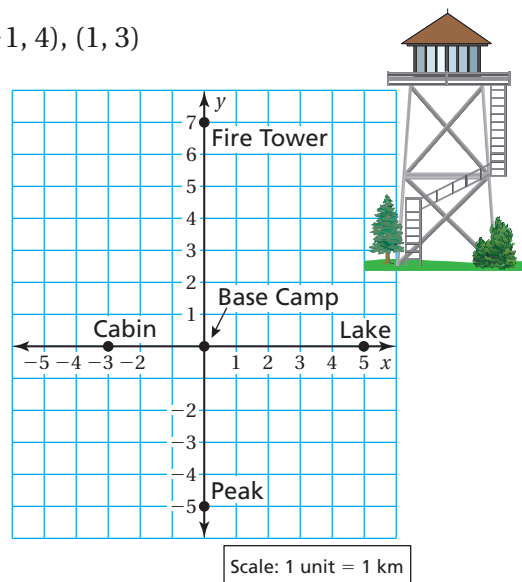

# 7 Chapter Review

## Review Key Vocabulary

square root, p. 290  
perfect square, p. 290  
radical sign, p. 290  
radicand, p. 290  
cube root, p. 296

perfect cube, p. 296  
theorem, p. 300  
legs, p. 302  
hypotenuse, p. 302  
Pythagorean Theorem, p. 302

irrational number, p. 310  
real numbers, p. 310  
distance formula, p. 320

## Review Examples and Exercises

### 7.1 Finding Square Roots (pp. 288–293)

Find  $-\sqrt{36}$ .

$-\sqrt{36}$  represents the  
negative square root.

Because  $6^2 = 36$ ,  $-\sqrt{36} = -\sqrt{6^2} = -6$ .

#### Exercises

Find the square root(s).

1.  $\sqrt{1}$

2.  $-\sqrt{\frac{9}{25}}$

3.  $\pm\sqrt{1.69}$

Evaluate the expression.

4.  $15 - 4\sqrt{36}$

5.  $\sqrt{\frac{54}{6}} + \frac{2}{3}$

6.  $10(\sqrt{81} - 12)$

### 7.2 Finding Cube Roots (pp. 294–299)

Find  $\sqrt[3]{\frac{125}{216}}$ .

Because  $\left(\frac{5}{6}\right)^3 = \frac{125}{216}$ ,  $\sqrt[3]{\frac{125}{216}} = \sqrt[3]{\left(\frac{5}{6}\right)^3} = \frac{5}{6}$ .

#### Exercises

Find the cube root.

7.  $\sqrt[3]{729}$

8.  $\sqrt[3]{\frac{64}{343}}$

9.  $\sqrt[3]{-\frac{8}{27}}$

Evaluate the expression.

10.  $\sqrt[3]{27} - 16$

11.  $25 + 2\sqrt[3]{-64}$

12.  $3\sqrt[3]{-125} - 27$

### 7.3 The Pythagorean Theorem (pp. 300–305)

Find the length of the hypotenuse of the triangle.

$$a^2 + b^2 = c^2$$

Write the Pythagorean Theorem.

$$7^2 + 24^2 = c^2$$

Substitute.

$$49 + 576 = c^2$$

Evaluate powers.

$$625 = c^2$$

Add.

$$\sqrt{625} = \sqrt{c^2}$$

Take positive square root of each side.

$$25 = c$$

Simplify.

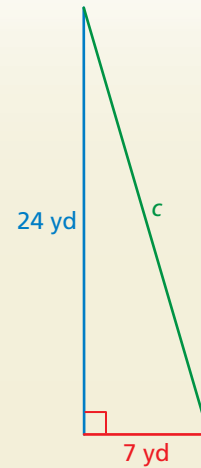

∴ The length of the hypotenuse is 25 yards.

#### Exercises

Find the missing length of the triangle.

13.

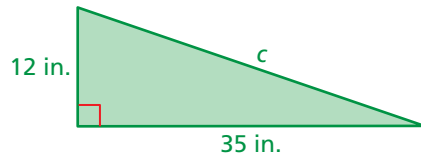

14.

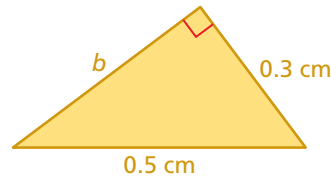

### 7.4 Approximating Square Roots (pp. 308–317)

a. Classify  $\sqrt{19}$ .

∴ The number  $\sqrt{19}$  is irrational because 19 is not a perfect square.

b. Estimate  $\sqrt{34}$  to the nearest integer.

Make a table of numbers whose squares are close to the radicand, 34.

Number	4	5	6	7
Square of Number	16	25	36	49

The table shows that 34 is between the perfect squares 25 and 36. Because 34 is closer to 36 than to 25,  $\sqrt{34}$  is closer to 6 than to 5.

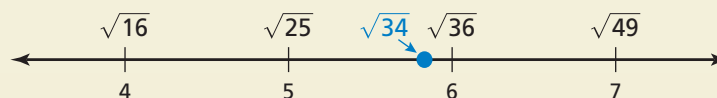

∴ So,  $\sqrt{34} \approx 6$ .

## Exercises

Classify the real number.

15.  $0.81\bar{5}$

16.  $\sqrt{101}$

17.  $\sqrt{4}$

Estimate the square root to the nearest (a) integer and (b) tenth.

18.  $\sqrt{14}$

19.  $\sqrt{90}$

20.  $\sqrt{175}$

Write the decimal as a fraction.

21.  $0.\bar{8}$

22.  $0.\overline{36}$

23.  $-1.\bar{6}$

## 7.5 Using the Pythagorean Theorem (pp. 318–323)

a. Is the triangle formed by the rope and the tent a right triangle?

$$\begin{aligned} a^2 + b^2 &= c^2 \\ 64^2 + 48^2 &\stackrel{?}{=} 80^2 \\ 4096 + 2304 &\stackrel{?}{=} 6400 \\ 6400 &= 6400 \quad \checkmark \end{aligned}$$

∴ It is a right triangle.



b. Find the distance between  $(-3, 1)$  and  $(4, 7)$ .

Let  $(x_1, y_1) = (-3, 1)$  and  $(x_2, y_2) = (4, 7)$ .

$$\begin{aligned} d &= \sqrt{(x_2 - x_1)^2 + (y_2 - y_1)^2} \\ &= \sqrt{[4 - (-3)]^2 + (7 - 1)^2} \\ &= \sqrt{7^2 + 6^2} \\ &= \sqrt{49 + 36} \\ &= \sqrt{85} \end{aligned}$$

Write the distance formula.

Substitute.

Simplify.

Evaluate powers.

Add.

## Exercises

Tell whether the triangle is a right triangle.

24.

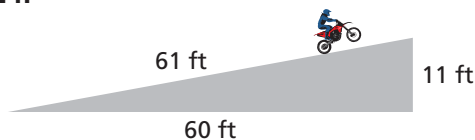

25.

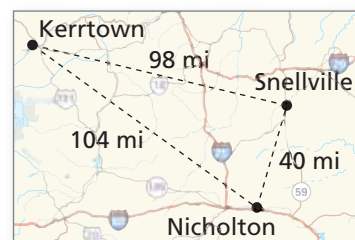

Find the distance between the two points.

26.  $(-2, -5), (3, 5)$

27.  $(-4, 7), (4, 0)$

# 7 Chapter Test

Find the square root(s).

1.  $-\sqrt{1600}$

2.  $\sqrt{\frac{25}{49}}$

3.  $\pm\sqrt{\frac{100}{9}}$

Find the cube root.

4.  $\sqrt[3]{-27}$

5.  $\sqrt[3]{\frac{8}{125}}$

6.  $\sqrt[3]{-\frac{729}{64}}$

Evaluate the expression.

7.  $12 + 8\sqrt{16}$

8.  $\frac{1}{2} + \sqrt{\frac{72}{2}}$

9.  $(\sqrt[3]{-125})^3 + 75$

10.  $50\sqrt[3]{\frac{512}{1000}} + 14$

11. Find the missing length of the triangle.

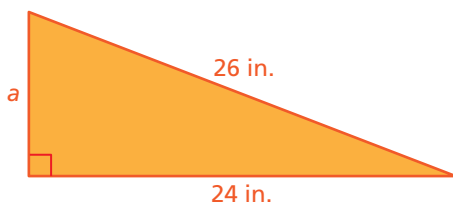

Classify the real number.

12.  $16\pi$

13.  $-\sqrt{49}$

Estimate the square root to the nearest (a) integer and (b) tenth.

14.  $\sqrt{58}$

15.  $\sqrt{83}$

Write the decimal as a fraction or a mixed number.

16.  $-0.\bar{3}$

17.  $1.\bar{24}$

18. Tell whether the triangle is a right triangle.

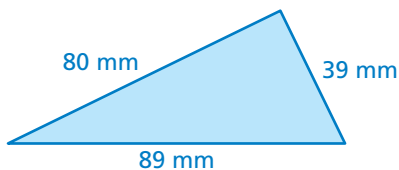

Find the distance between the two points.

19.  $(-2, 3), (6, 9)$

20.  $(0, -5), (4, 1)$

21. **SUPERHERO** Find the altitude of the superhero balloon.



61 ft

x

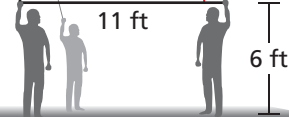

# 7 Standards Assessment

1. The period  $T$  of a pendulum is the time, in seconds, it takes the pendulum to swing back and forth. The period can be found using the formula  $T = 1.1\sqrt{L}$ , where  $L$  is the length, in feet, of the pendulum. A pendulum has a length of 4 feet. Find its period. (8.EE.2)

- A. 5.1 sec                      C. 3.1 sec  
 B. 4.4 sec                      D. 2.2 sec

2. Which parallelogram is a dilation of parallelogram  $JKLM$ ? (Figures not drawn to scale.) (8.G.4)

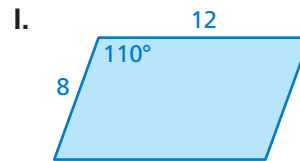
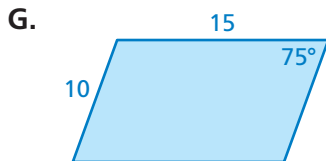
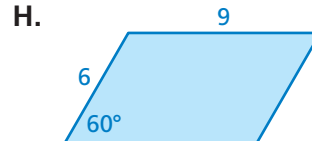
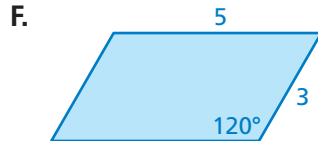
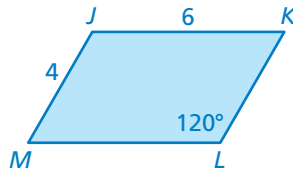

3. Which equation represents a linear function? (8.F.3)

- A.  $y = x^2$                       C.  $xy = 1$   
 B.  $y = \frac{2}{x}$                       D.  $x + y = 1$

4. Which linear function matches the line shown in the graph? (8.F.4)

- F.  $y = x - 5$                       H.  $y = -x - 5$   
 G.  $y = x + 5$                       I.  $y = -x + 5$

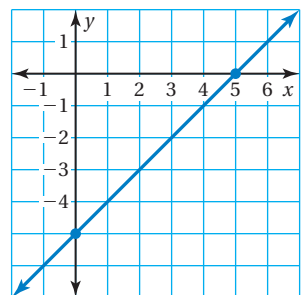

**Test-Taking Strategy**  
**Answer Easy Questions First**

Was Fluffy in our kitchen?

There are  $\sqrt{4}$  different tongue prints on the butter. How many cats licked the butter?  
 (A) 1    (B) 2    (C) -2    (D) 4

"Scan the test and answer the easy questions first. You know the square root of 4 is 2."

5. A football field is 40 yards wide and 120 yards long. Find the distance between opposite corners of the football field. Show your work and explain your reasoning. (8.G.7)



6. A computer consultant charges \$50 plus \$40 for each hour she works. The consultant charged \$650 for one job. This can be represented by the equation below, where  $h$  represents the number of hours worked.



$$40h + 50 = 650$$

How many hours did the consultant work? (8.EE.7b)

7. You can use the formula below to find the sum  $S$  of the interior angle measures of a polygon with  $n$  sides. Solve the formula for  $n$ . (8.EE.7b)

$$S = 180(n - 2)$$

- A.  $n = 180(S - 2)$                       C.  $n = \frac{S}{180} - 2$   
 B.  $n = \frac{S}{180} + 2$                         D.  $n = \frac{S}{180} + \frac{1}{90}$
8. The table below shows a linear pattern. Which linear function relates  $y$  to  $x$ ? (8.F.1)

<b>x</b>	1	2	3	4	5
<b>y</b>	4	2	0	-2	-4

- F.  $y = 2x + 2$                               H.  $y = -2x + 2$   
 G.  $y = 4x$                                     I.  $y = -2x + 6$
9. An airplane flies from City 1 at  $(0, 0)$  to City 2 at  $(33, 56)$  and then to City 3 at  $(23, 32)$ . What is the total number of miles it flies? Each unit of the coordinate grid represents 1 mile. (8.G.8)



10. What is the missing length of the right triangle shown? (8.G.7)

- A. 16 cm                                      C. 24 cm  
 B. 18 cm                                      D.  $\sqrt{674}$  cm

